



For Android™ 7.1.2

Enterprise Mobility

PM45

User Manual

User Manual

Please note your phone is battery-embedded design with removable battery and battery cover. Unauthorized personnel are strictly prohibited from disassembling the phone. Make sure to use only the power adapter (5V 2A Output AC/DC) that came with PM45.

In case your phone does not work as expected, you are strongly recommended to restart it by pressing and holding the power button for at least 8 seconds until the startup screen appears. If your phone has encountered a serious error and cannot be recovered, you should reset your phone to factory settings by using the menu, either “Backup & Reset”, or “Factory Reset”. For more details, please refer to “[Factory data reset](#)” section.

Note: Please be cautious while performing the factory data reset. Because this will erase personalized settings and data saved in your phone, such as SMS, Contacts, Music, etc.



www.sar-tick.com

Body-worn Operation

This device was tested for typical body-worn operations with the front & back of the phone kept 0.2 inches (0.5 cm) between the user's body and the front & back of the phone. A minimum separation distance of 0.2 inches (0.5 cm) must be maintained between the user's body and the front & back of the phone. Any belt clips, holsters, and similar accessories containing metallic components may not be used. Body-worn accessories that cannot maintain 0.2 inches (0.5 cm) separation distance between the user's body and the front & back of the phone, and have not been tested for typical body-worn operations should be avoided.



PROTECT YOUR HEARING

To prevent possible hearing damage, do not listen at high volume levels for long periods. Exercise caution when holding your device near your ear while the loudspeaker is in use.

Rev 03

Table of Contents

User Manual	1
Table of Contents	2
Getting Started.....	4
Major Parts	4
Accessory	5
Setup PM45.....	7
Charge PM45	11
Turn On/Off PM45.....	12
Learning the basics.....	13
Use a keypad	13
Use a touch screen	15
Setup Wizard.....	17
Home Screen, Apps and Widget.....	25
Status & Notifications Icons	36
Set a Lock screen.....	38
Manage a display	40
Make a call	45
Add to a contact.....	47
Send a message.....	51
Change a SIM card settings	54
Connect to your Wi-Fi network.....	57
Make a Wi-Fi hotspot.....	59
Connect with Bluetooth device	62
Use a Camera.....	65
Manage files and folders	68
MTP connection with PC.....	75
Change a Touch Sensitivity	78
Use a Google Assistant.....	82
OS Update	85
OS Image update from a Storage.....	85

OS Image update from the FOTA.....	87
Factory data reset	90
Factory data reset from Settings.....	90
Force Factory data reset	92
EmKit.....	96
EmKit Secure	97
EmKit Remote.....	100
EmKit Tools.....	108
EmKit Demos	116
Safety Information	118

Major Parts

Getting Started

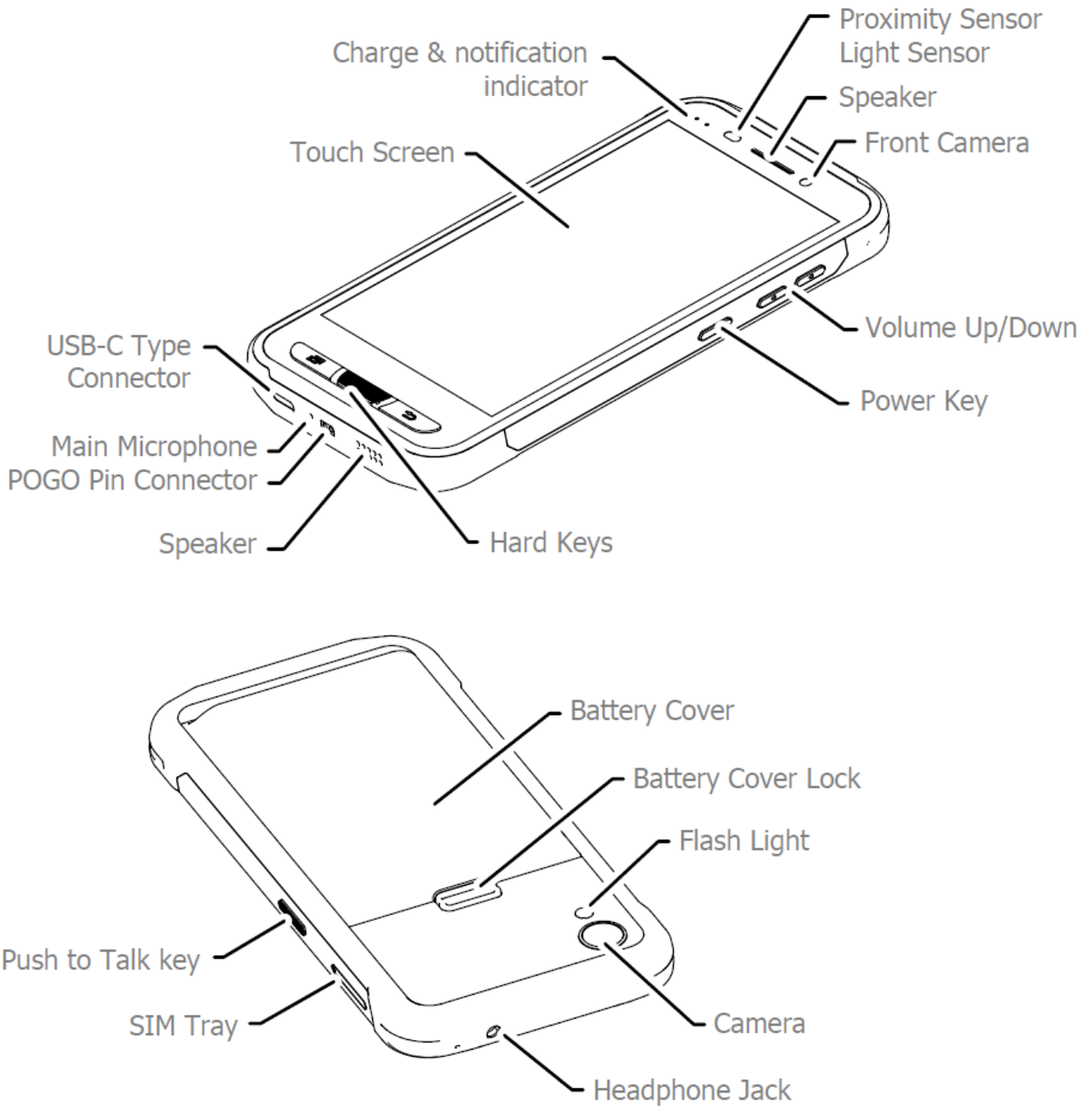

Accessory

Getting Started

AC/DC adapter (5V2A)

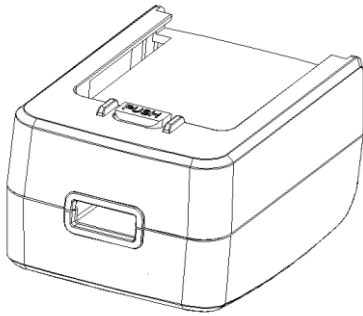

Plug (US/ EU/UK)

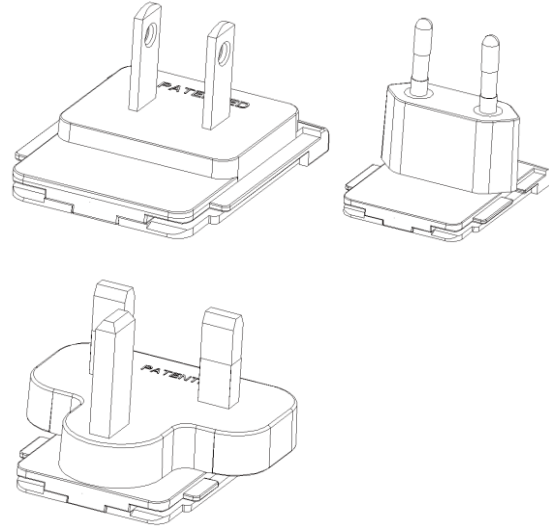

USB Type-C cable



Standard Battery (2,900mAh)

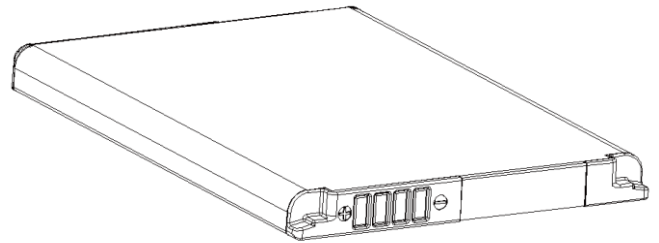

SIM Tray Eject Pin

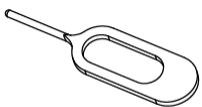

Extended Battery (5,800mAh)

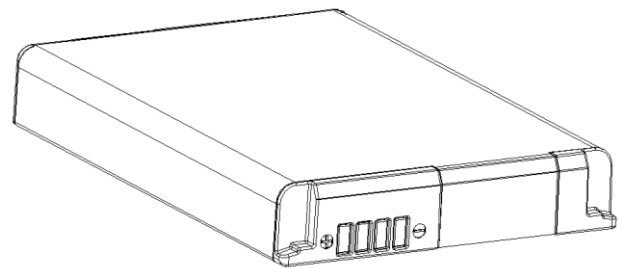

Accessory

Getting Started

LCD Protection Film



Optional Accessories

2 Slot Cradle

(Up to three 2 slot Cradles can be linked to charge 6 devices at a time)

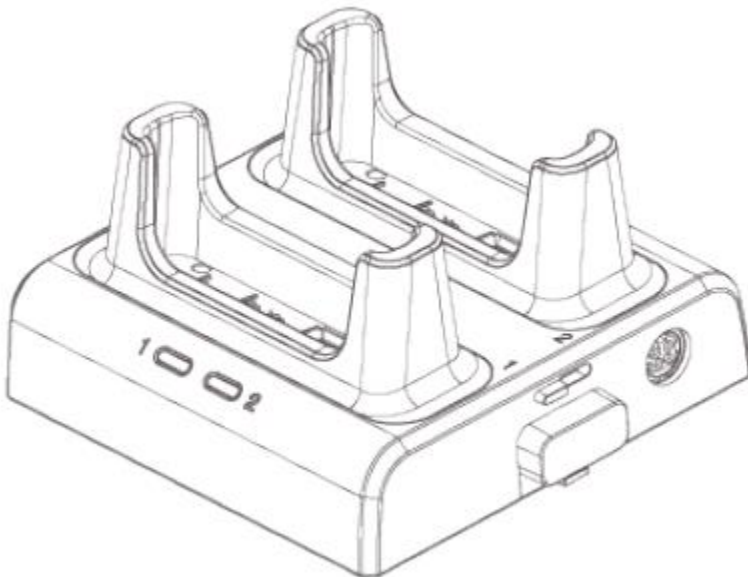

Setup PM45

Getting Started

Remove the Battery Cover

1. Push up the Battery Cover Lock

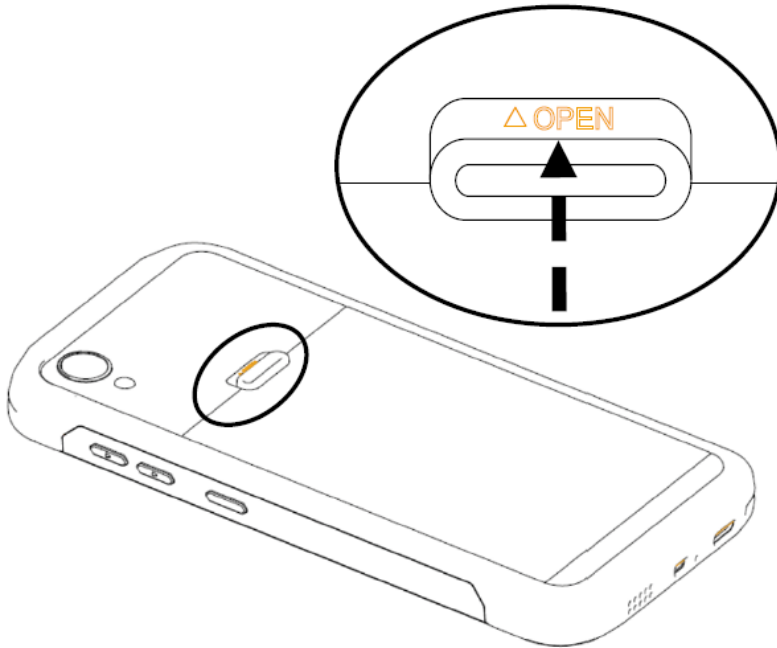

2. Lift up the Battery Cover Lock

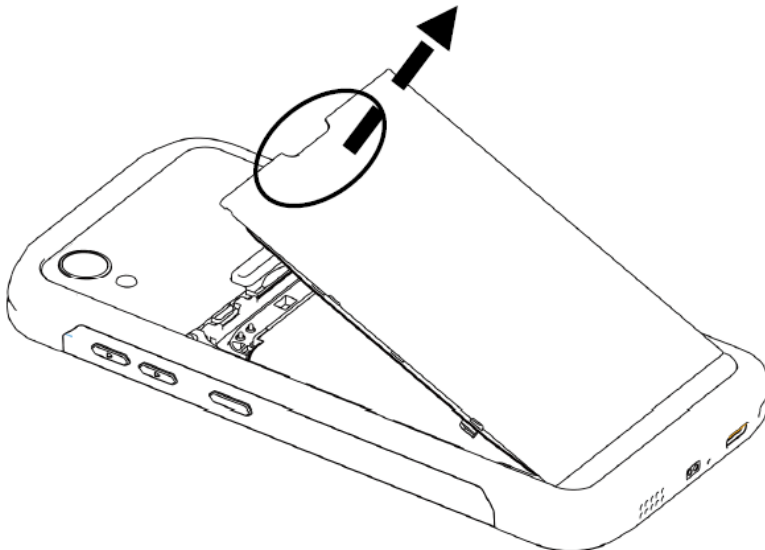

3. Remove the Battery Cover Lock

Setup PM45

Getting Started

Insert the Battery

1. Insert Battery from the top first, and then put in the bottom

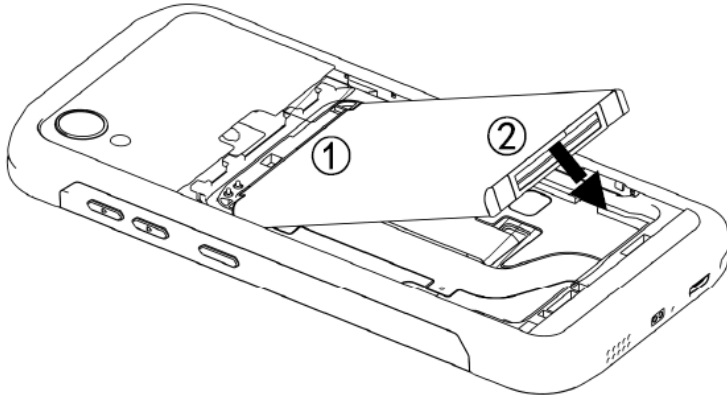

2. Insert the battery cover from the bottom first

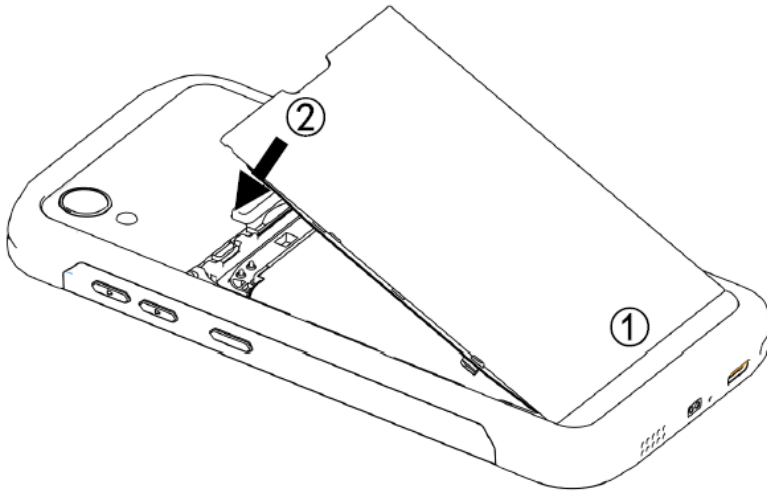

3. Push down the battery cover lock

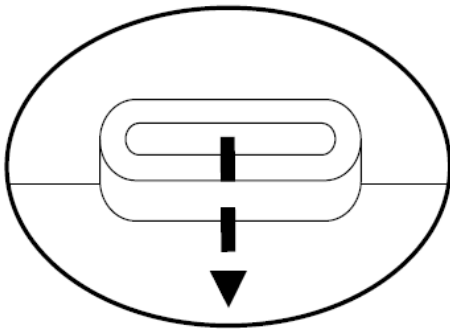

Setup PM45

Getting Started

Install SIM card / microSD card

1. Insert the SIM Tray Eject Pin into the tray eject hole.

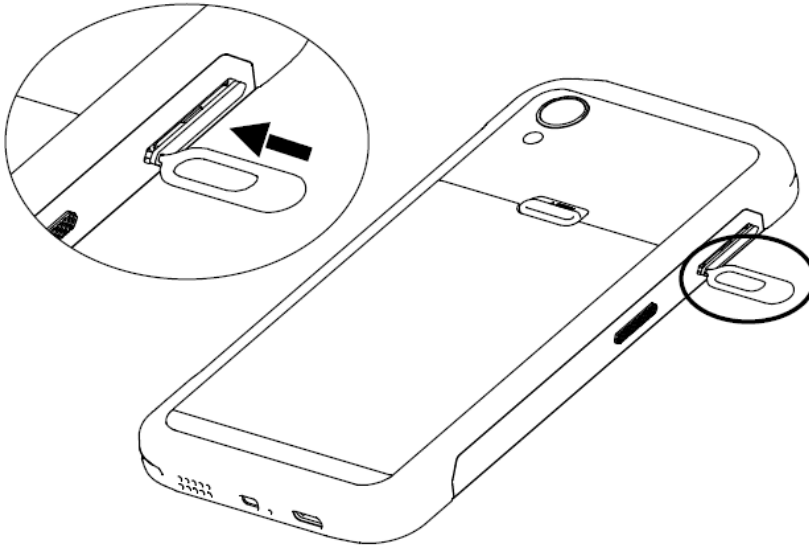

2. Push the pin all the way into the hole until the tray ejects, and then pull the tray out

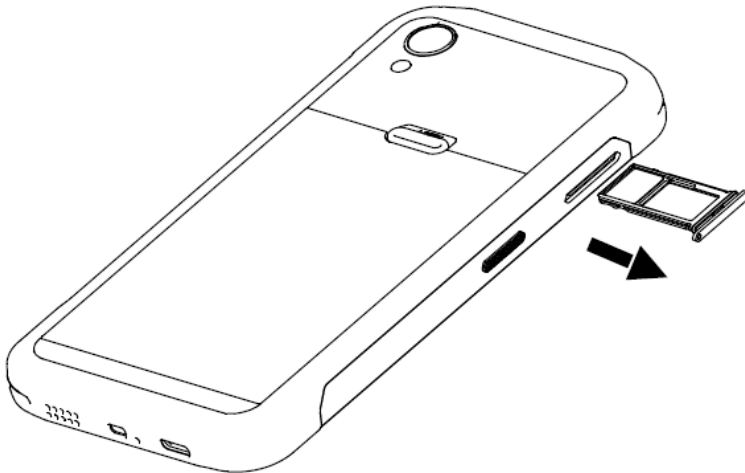

Setup PM45

Getting Started

3. Insert the SIM/micro SD card into the slot. Please insert SIM card and SD Card as shown below. (PM45 is Dual SIM Dual Standby model)

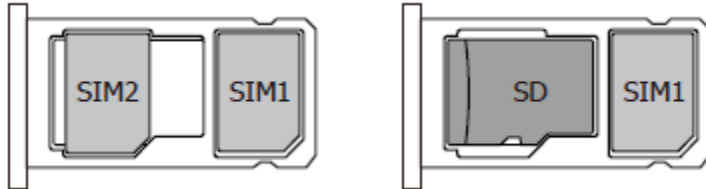

Gold contacts should face down

Note: Your device only supports the Nano SIM cards. Do not insert a modified card which is thicker than the standard Nano SIM card. Modified card may damage the card slot.

PM45 supports up to 32GB microSD card

4. Press on the cover of the tray to close it tightly.

Charge PM45

Getting Started

1. Insert USB Type-C cable into the adapter and connect to an electrical socket to charge first. Connect another side USB cable to the PM45. (You can also charge the PM45 with optional accessory such as cradle)

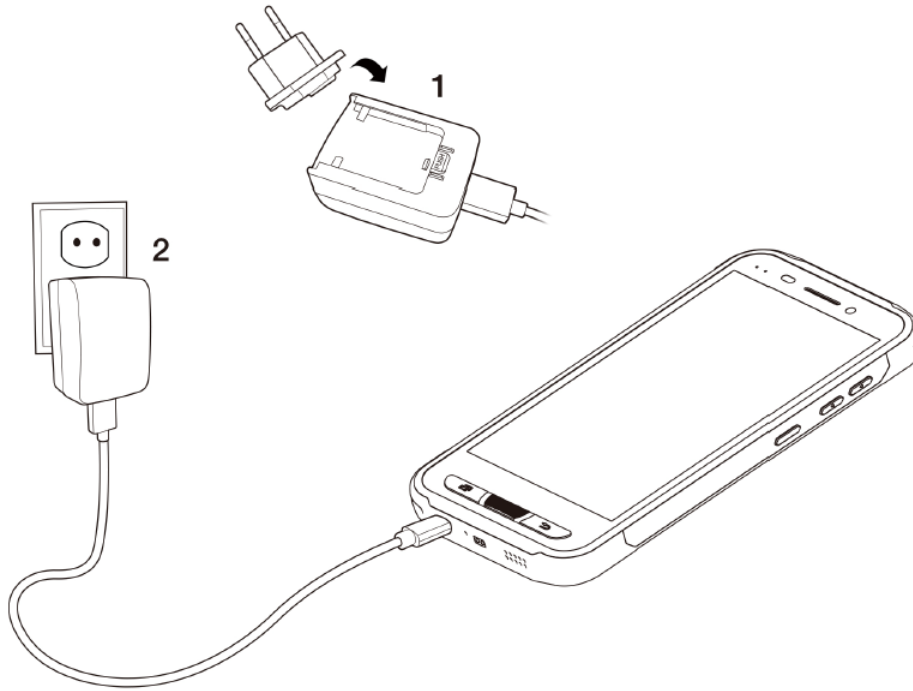

2. LED indicator will display charging status.

Steady Red	Battery is charging or Battery level is low
Blinking Red	Battery level is critical low
Steady Green	Battery is fully charged

Standard Battery	2,900mAh 3.85V
Backup Battery	5,800mAh 3.85V
Charging time	Standard Battery : About 4 hours Extend Battery : About 6 hours

Note: Always use an original charger and cable from the Point Mobile. Other chargers and cables may damage PM45. In addition, make sure connector, charger, cables are not wet.

Turn On/Off PM45

Getting Started

Turn On

1. Press and hold the “Power Key” for a few seconds.
2. When PM45 enter to the boot mode, it will display “SMART BEYOND RUGGED” logo
3. Release the “Power Key” and wait until PM45 finish booting

Note: If you cannot turn on your PM45, try below steps

- To turn on PM45, battery needs to be charged certain level. Please charge first
- Press and hold the “Power key” for over 8 seconds to force reboot

Turn Off

1. Press and hold the “Power Key” until you see the power menu

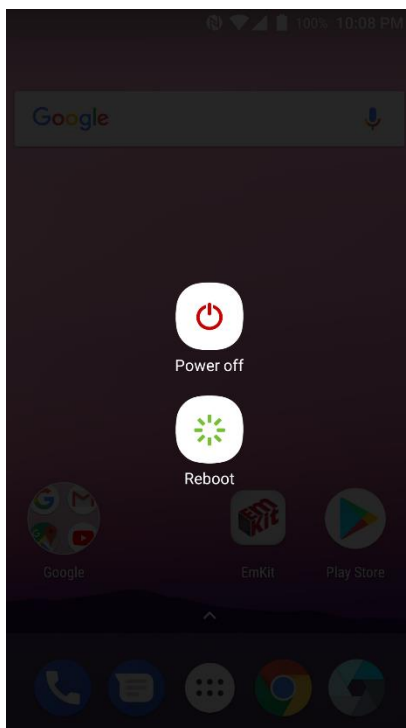

2. Touch “Power Off”

Use a keypad

Learning the basics

Power key



Press

- Lock the screen / Light up the screen.

Press and hold

- Display the power menu “Power Off / Restart / Airplane mode”

Press and hold for over 8 seconds

- Forced to reboot

Press and hold the “Power” key and “Volume Down” key together

- Screen capture

Volume keys



In general

- Adjusts the ringtone volume or “Mute” the ringtone of an incoming call.

In call mode

- Adjusts the earpiece or headset volume.

In Music / Video / Streaming

- Adjusts the media volume.



In camera preview

- Take the photo by pressing Volume Up or Down key.

Push to Talk key (Programmable Key)



In general

- Run Push to Talk service
- Programmable key

Please set function in EmKit – Program Buttons. Please find details on page 99

Use a keypad

Learning the basics

Front panel

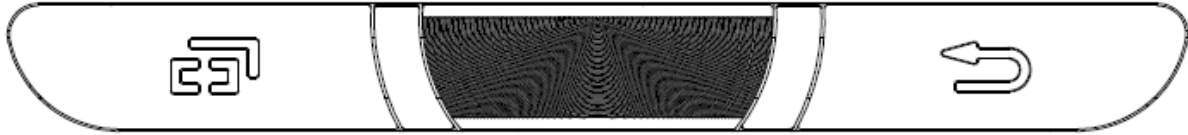

Recent Apps key

- Press to see recently used apps.

Home key

- From any apps or screens, press to return to the Home screen.

Back key

- Press to go back to the previous screen, or to close a dialog box, options menu, notification panel, etc.

Use a touch screen

Learning the basics

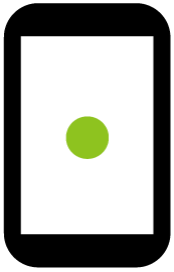

Touch

One-finger press

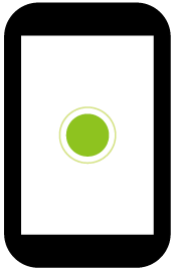

Double touch

One-finger press, lift, one-finger press, lift for “Zoom in”



Long press

One-finger press, wait, lift for “Select an item”

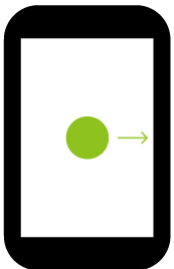

Drag, Swipe, or Fling

One-finger press, move, lift for “Scroll” or “Tilt”

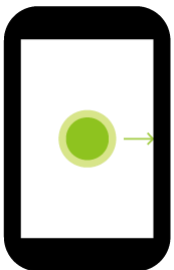

Long-press drag

One-finger press, wait, move, lift for “Pick up and move” or “select multiple items”

Use a touch screen

Learning the basics

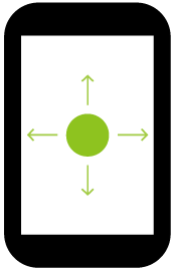

Scroll

Vertical or horizontal swipe in a single direction

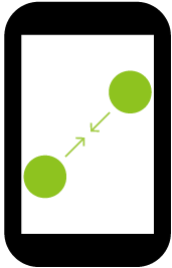
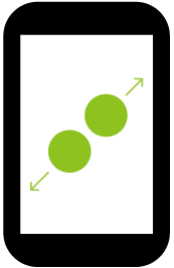

Pinch Open & Close

Two-finger press, move outwards and inwards, lift for “Zoom in and out”

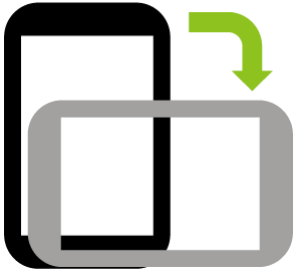

Rotate

When PM45 is turning sideways, screen orientation is changing

Setup Wizard

Learning the basics

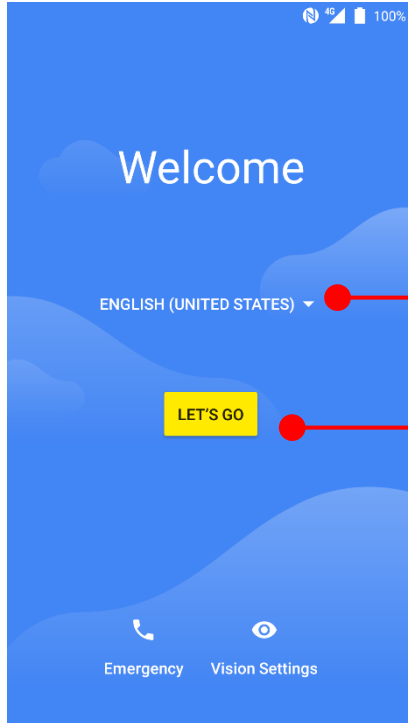

When you power on your device very first time or boot after factory reset, you need to setup your device

Language Selection

- Choose your language during setup process.

Touch here to start setup your device

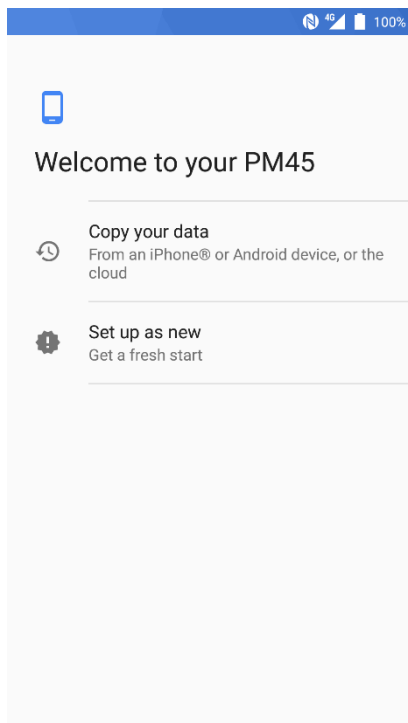

You can copy other device's settings to your PM45 or setup as a new device

Copy your data

- You can copy your settings from other Android phone or Google account or iPhone

Set up as new

- Set your PM45 as your new device

Setup Wizard

Learning the basics

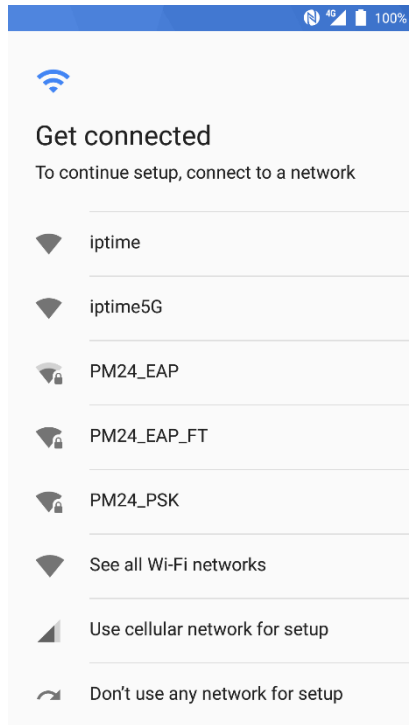

Copy your data

To copy your settings, please connect your PM45 to Wi-Fi network

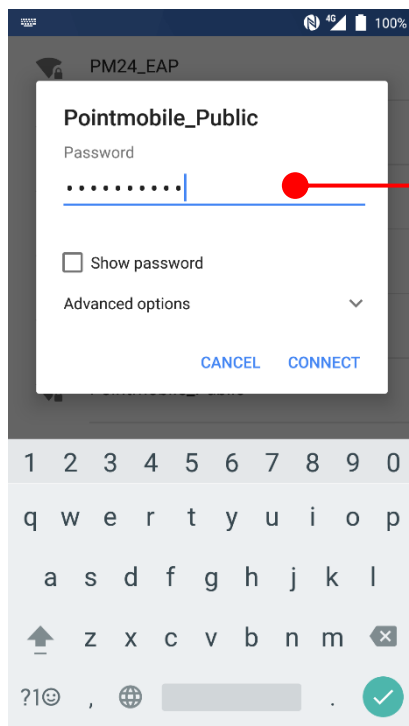

Please select Wi-Fi network and input the password (If required)



Icon means: Open Wi-Fi network. You don't need to enter the password



Icon means: Secured Wi-Fi network. To connect this Wi-Fi, you need to enter the password

Setup Wizard

Learning the basics

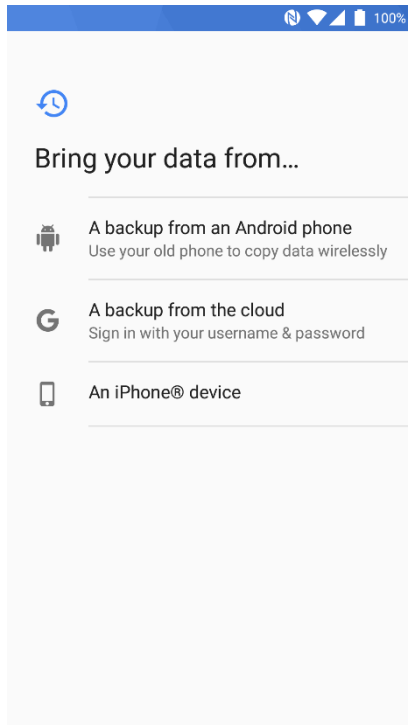

Choose the device or cloud where you want to copy the settings.

Setup Wizard

Learning the basics

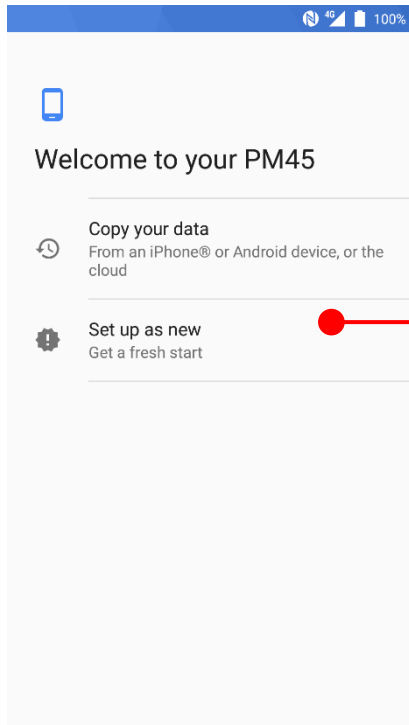

Setup as new

- Touch here to set your PM45 as your new device

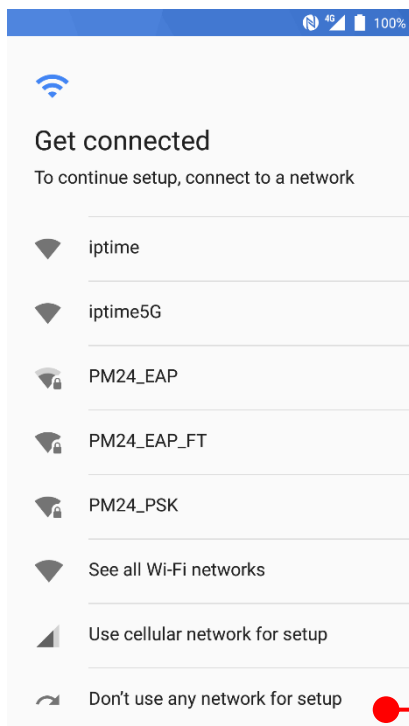

During setup process, Google services setup required.
Please connect your device to your Wi-Fi network.

You can skip the Wi-Fi connection process and set later.
Settings → Wi-Fi

Setup Wizard

Learning the basics

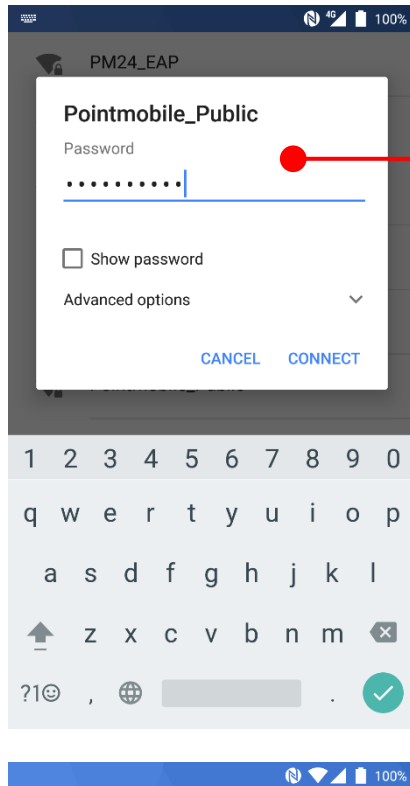

Please select Wi-Fi network and input the password (If required)



Icon means: Open Wi-Fi network. You don't need to enter the password



Icon means: Secured Wi-Fi network. To connect this Wi-Fi, you need to enter the password



Sign in

with your Google Account. [Learn more](#)

Email or phone



Please sign in to your Google Account. You may skip this process and sign in later

[Forgot email?](#)

[Create account](#)

SKIP



You may skip the Google account sign in process and set later. Settings → Accounts → Add account → Google

Setup Wizard

Learning the basics

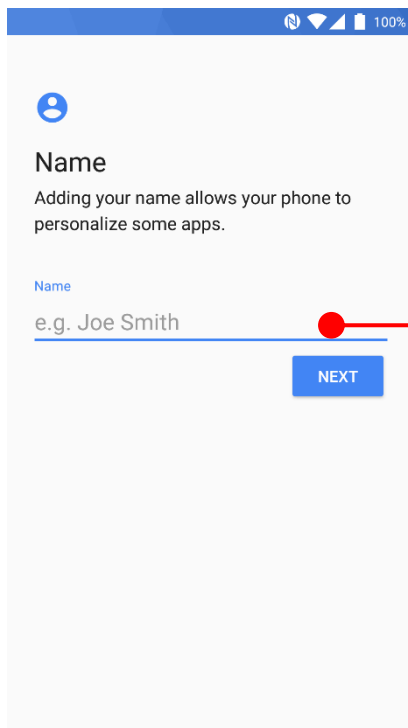

After your Google account login, you can set PM45's name. Touch here to set a name

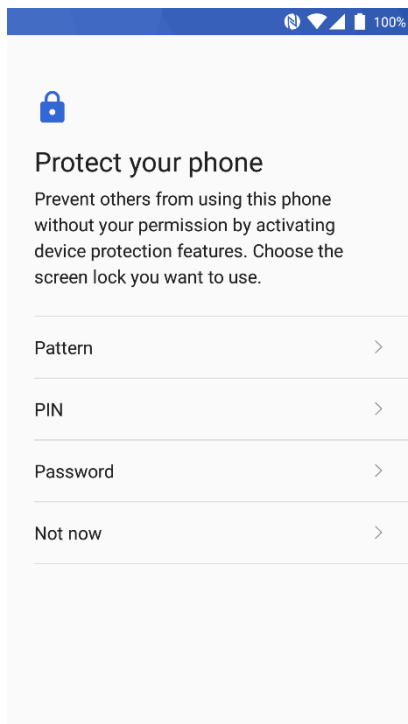

Choose security option for lock screen. You set specific pattern or PIN or password here. You may skip this process and set later

Setup Wizard

Learning the basics



Google services

Tap to learn more about each service, such as how to turn it on or off later. Data will be used according to Google's [Privacy Policy](#).

Location

- 
Help apps find location

Use Google's location service to help apps determine your location. Anonymous location data will be sent to Google when your device is on.
- 
Improve location accuracy

Allow apps and services to scan for Wi-Fi and Bluetooth.

MORE

To review the Google services option, please touch **MORE** button. You can turn On/Off specific service



Help improve your Android experience by automatically sending diagnostic and device and app usage data to Google. This will help improve battery life, app stability, network connectivity, and more. If you turned on additional Web & App Activity, this information will be stored with your account so you can manage it in My Activity.

- 
Install updates & apps

By continuing, you agree that this device may also automatically download and install updates and apps from Google, your carrier, and your device's manufacturer, possibly using cellular data. Some of these apps may offer in-app purchases. You can remove these apps at any time. You also hereby consent and grant preloaded Google apps permission to access information and functions on your device. See [this page](#) for more information on usage of these permissions.

If you continue, you also agree to the [Google Terms of Service](#).

AGREE

After your reviewing and set Google services option, touch **AGREE** button for next step

Setup Wizard

Learning the basics

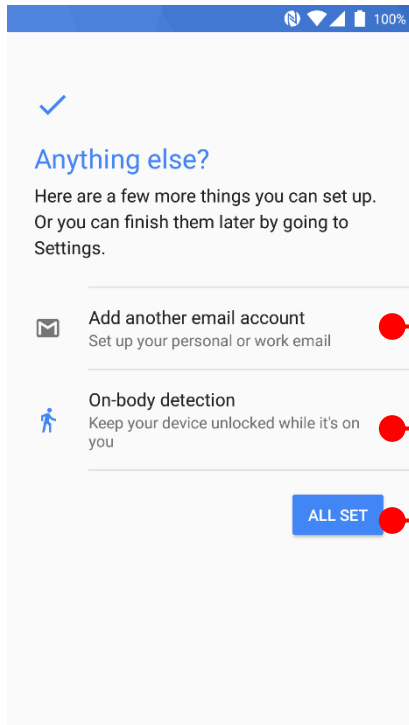

Touch to setup another e-mail account

Touch to use Smart Lock On-body detection

If you set up is done, touch ALL SET extra Touch an icon to run an app, open folder, etc

Home Screen, Apps and Widget

Learning the basics

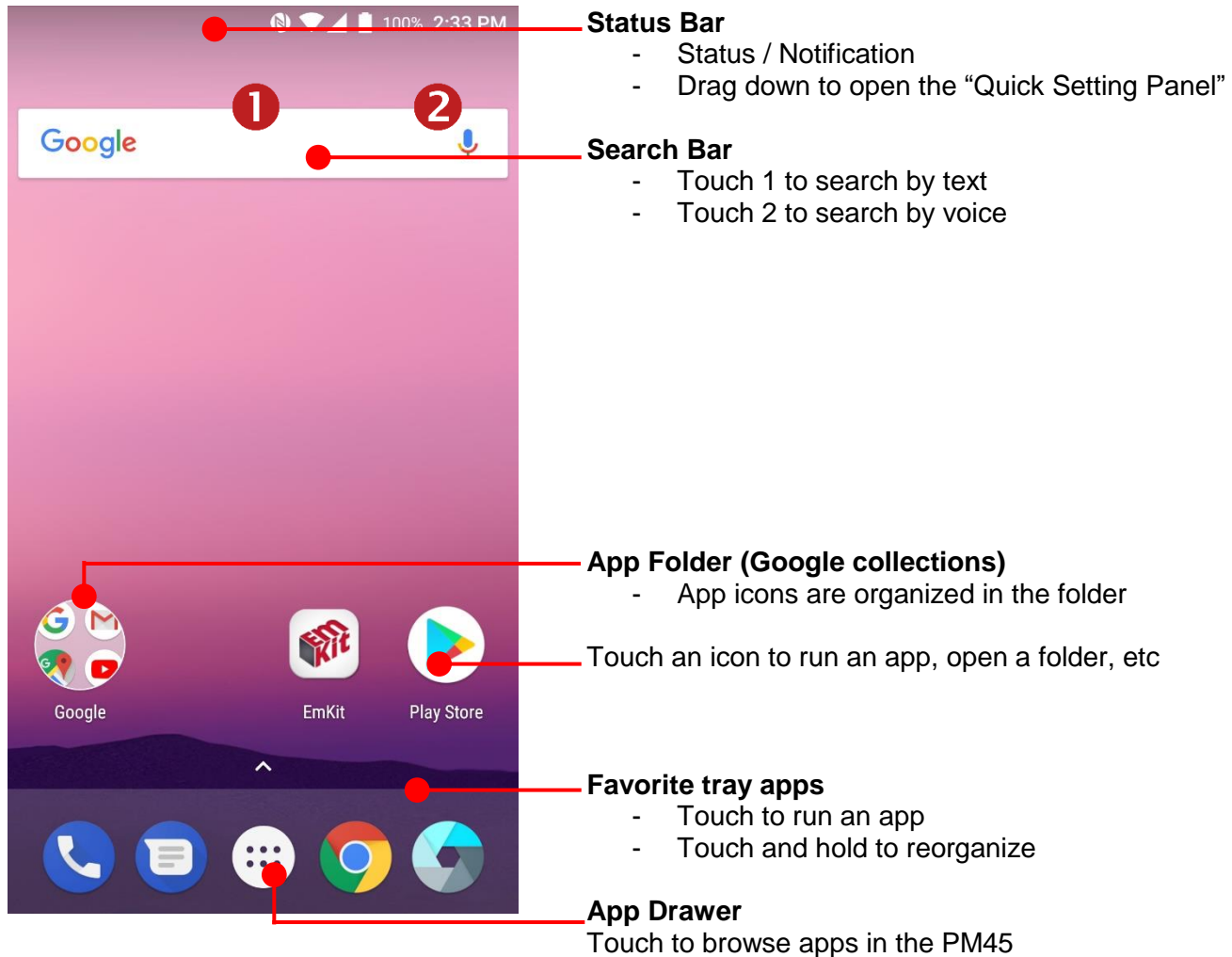

Home Screen, Apps and Widget

Learning the basics

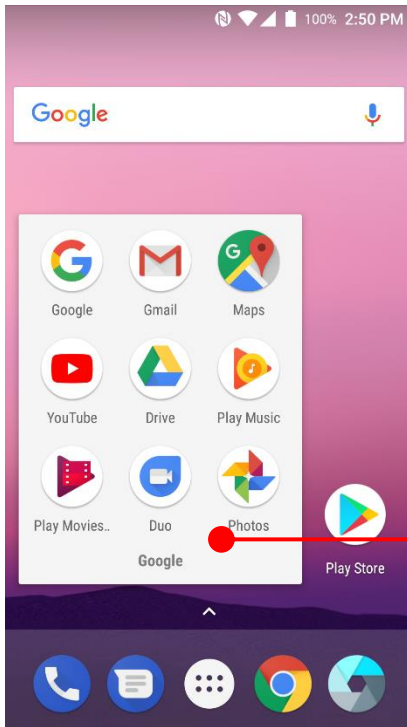

To access app folder (Google collections)

- Touch the app folder then you will see apps in the folder.
- To change app folder's name, touch the bottom area of the folder.

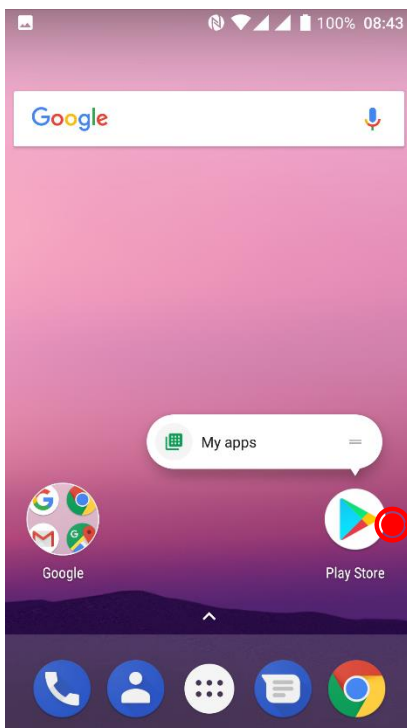

To see App's option for quick access

- Long press the app icon. Then you will see options from the app. Here option may differ by app

Home Screen, Apps and Widget

Learning the basics

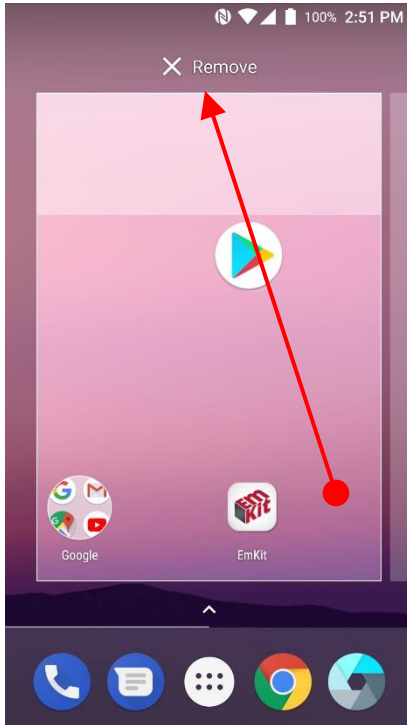

Organize the app icon in the home screen

- Long-press drag the app icon and place where you want. You may place app icon to next panel
- If you want to remove the app icon, drag it to "Remove" area and release

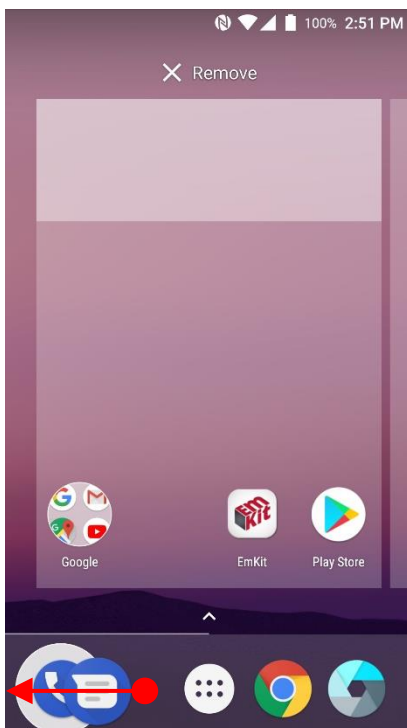

Create "App Folder"

- Long press the app icon to another app icon. This will create the "App Folder"
- To set the folder name, touch the "Unnamed Folder" and rename it

Home Screen, Apps and Widget

Learning the basics

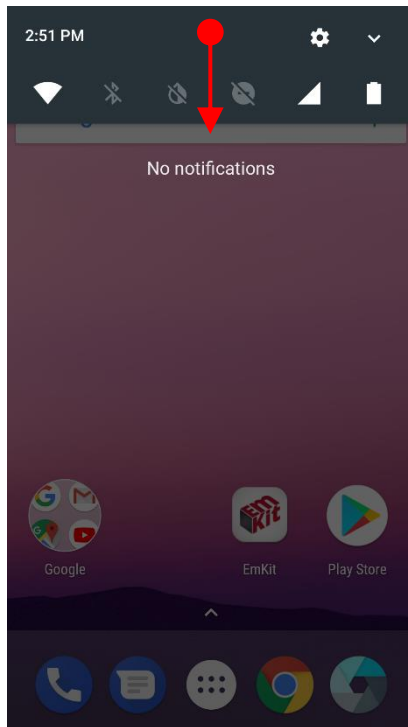

Notification panel

When there is notification from the Android (system) or the App, you can check details by drag down the "Status Bar".

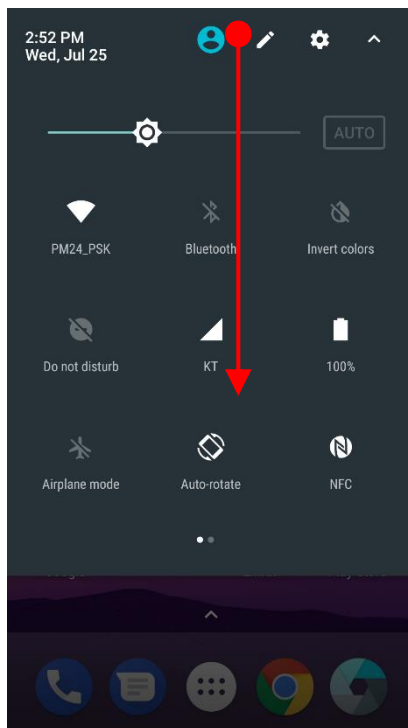

Quick setting panel

You can access "Quick setting panel" by drag down the "Notification panel". You can enable / disable functions or change modes easily.

Home Screen, Apps and Widget

Learning the basics

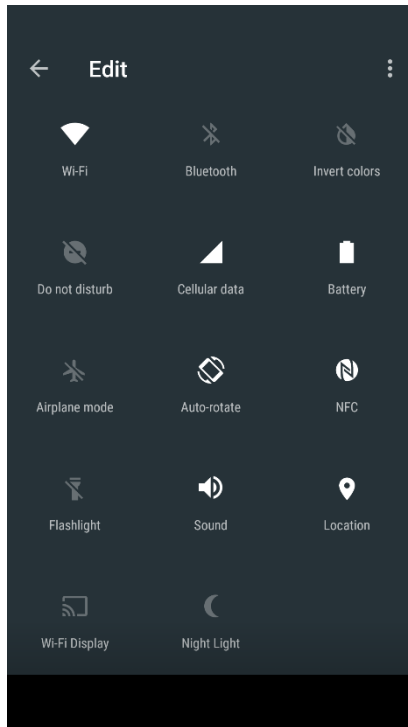

Edit Quick settings panel

To change the order of icon in the Quick settings panel, touch the  Edit icon

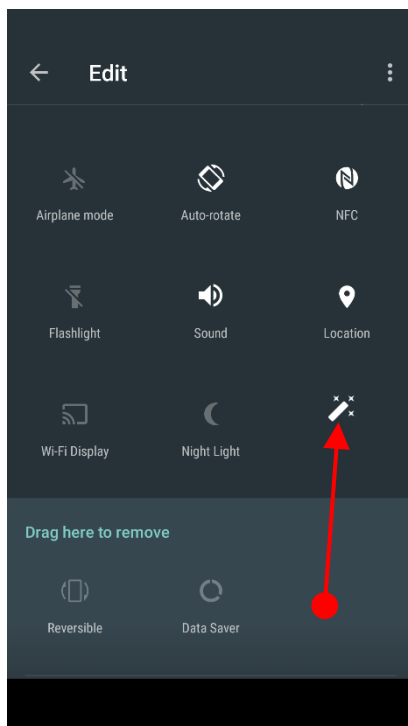

By dragging the icon, you can customize the Quick settings panel

Home Screen, Apps and Widget

Learning the basics

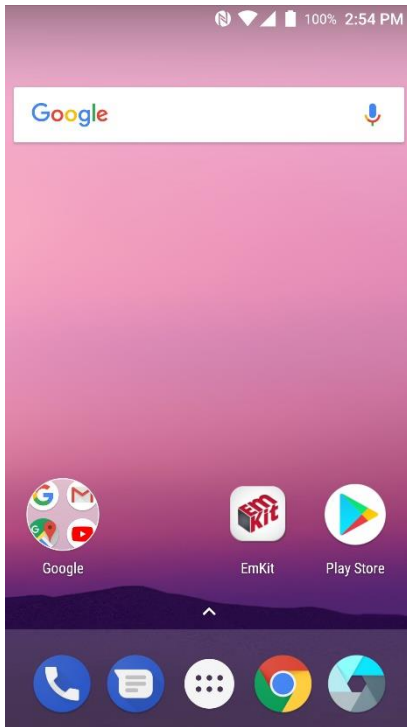

Touch the  App drawer icon, to see apps in your PM45

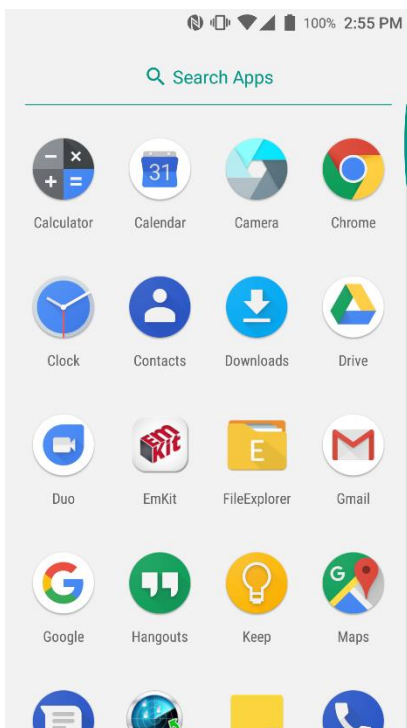

All installed apps are listed alphabetically

- Tap app icon to run.
- Long press, specific app icon to place to the “Home Screen”.

Home Screen, Apps and Widget

Learning the basics

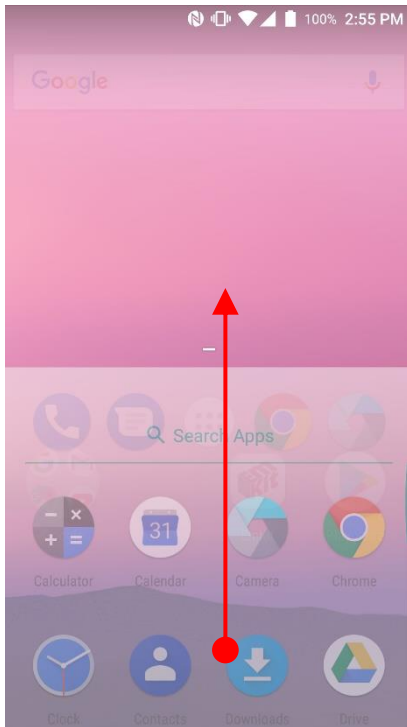

By drag up the Favorite tray apps area, you can also access to app list in your PM45

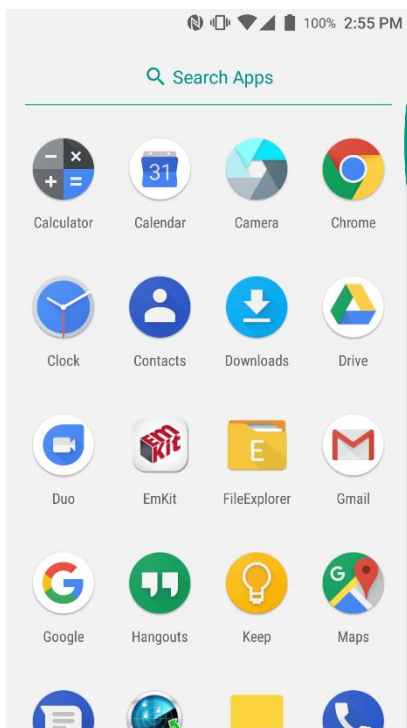

Home Screen, Apps and Widget

Learning the basics

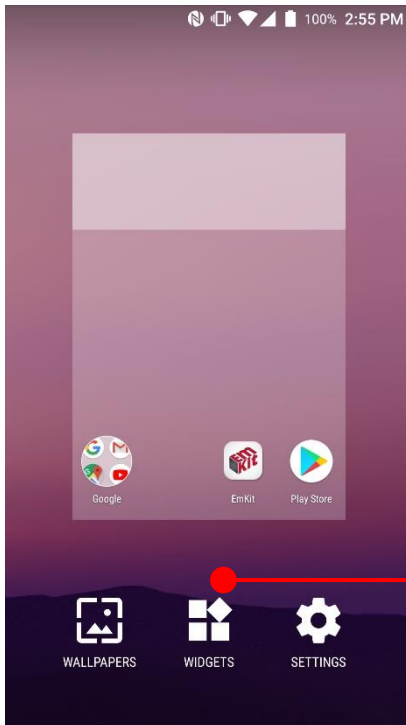

To add a Widget in the Home screen, long press the empty space. Then you will see **WALL PAPERS, WIDGETS, SETTINGS** menu. Touch **WIDGETS**

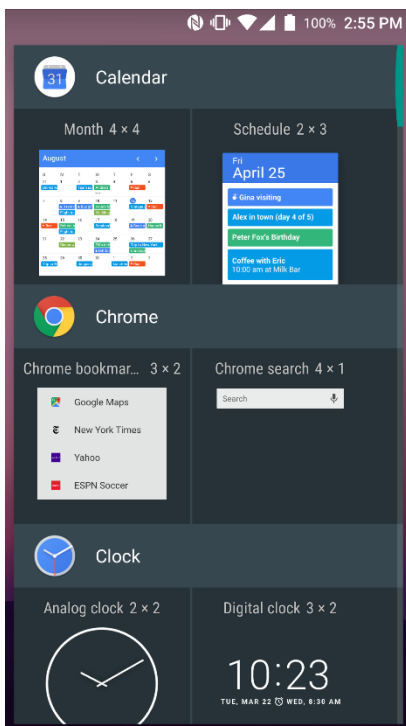

Available widgets are listed. Among the list select the widget which you want to add and place it to the Home screen by drag and drop

Home Screen, Apps and Widget

Learning the basics

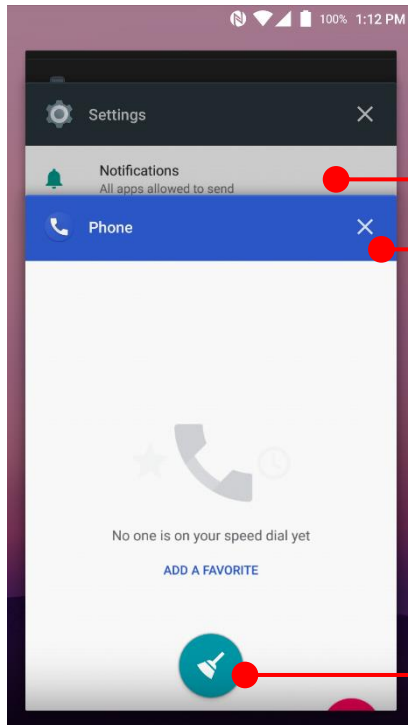

By pressing the  Recent button in the keypad, you can see app list which you access

Touch the app, if you want to use or access the app.

If you want to close individual app, long press the app and then touch  icon

If you close all of the apps, then touch **Brush** icon

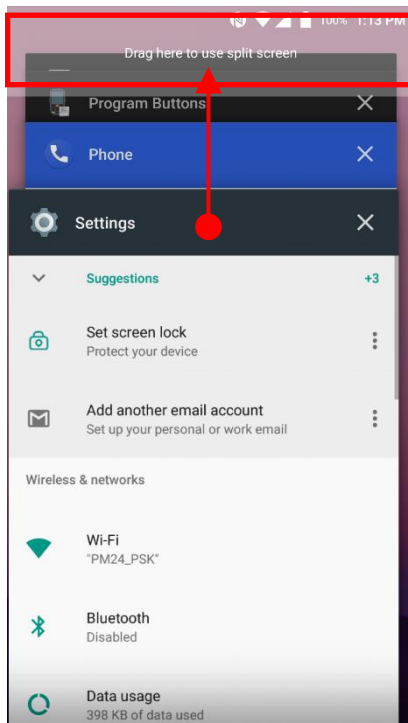

To see the two apps in the screen, please try **Split screen** function.

In the recent app list, long press - drag and drop the one of the app to the top area

Home Screen, Apps and Widget

Learning the basics

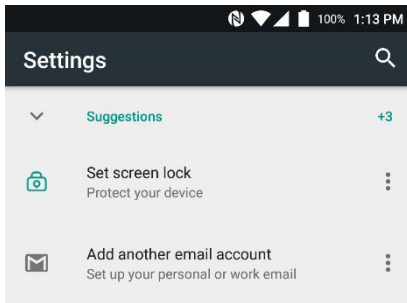

Now primary app is selected. Touch another app to see in the screen.

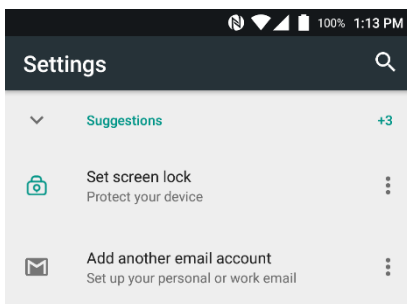
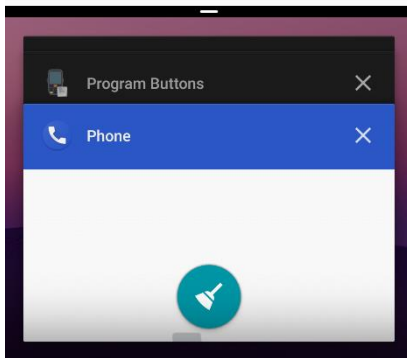

By selecting another app, you can see two apps in the screen

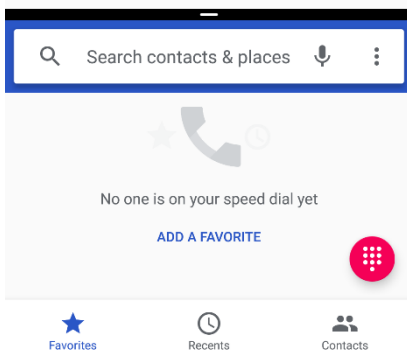

Note: Some of the app may not support split screen function

Home Screen, Apps and Widget

Learning the basics

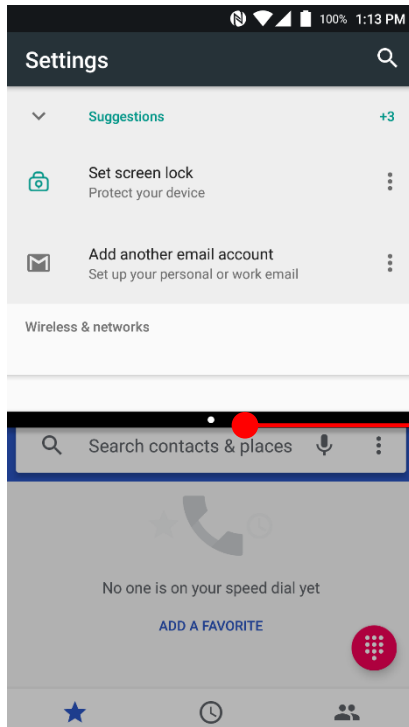





























By scroll up or down the black bar in the middle, you can exit split screen mode.

Status & Notifications Icons

Learning the basics













Status icons

	GPRS connected		GPRS in use
	EDGE connected		EDGE in use
	3G connected		3G in use
	4G connected		4G in use
	Signal strength		No signal
	Roaming		Airplane mode
	No SIM card installed		
	WLAN is on		Connected to a WLAN network
	Bluetooth is on		Connected to a Bluetooth device
	Battery is full		Battery is partially drained
	Battery is low		Battery is very low
	Battery is charging		
	GPS is on		Alarm is set
	Speaker phone is on		Headset connected
	Vibrate mode/ Mute		Phone mic is mute

Status & Notifications Icons

Learning the basics



Notification icons

	Missed call		New SMS or MMS message
	New Email		Connected to VPN network
	Upcoming event		Screenshot captured
	Preparing SD card		SD card removed, unexpectedly
	OTG device connected		
	File uploaded		File downloaded
	There are more notifications		Other input method available

Set a Lock screen

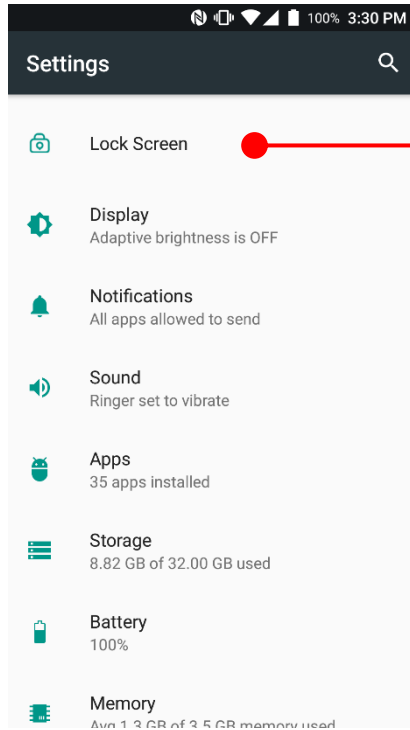
Learning the basics



Touch  "App drawer" icon →  "Settings" and then "Lock Screen"

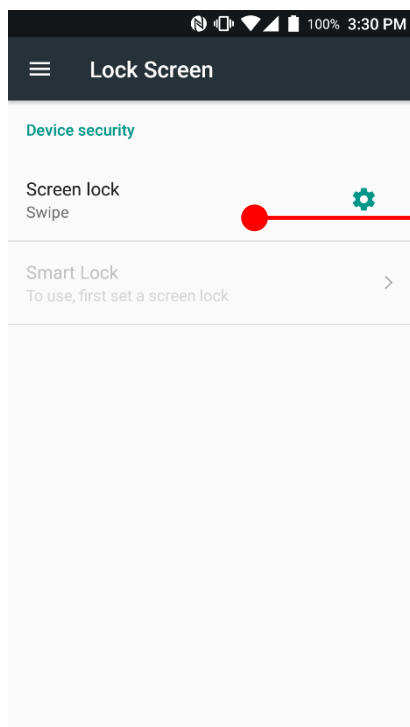

You can see Screen lock type which is currently set. To change the screen lock, please touch the menu.

Set a Lock screen

Learning the basics

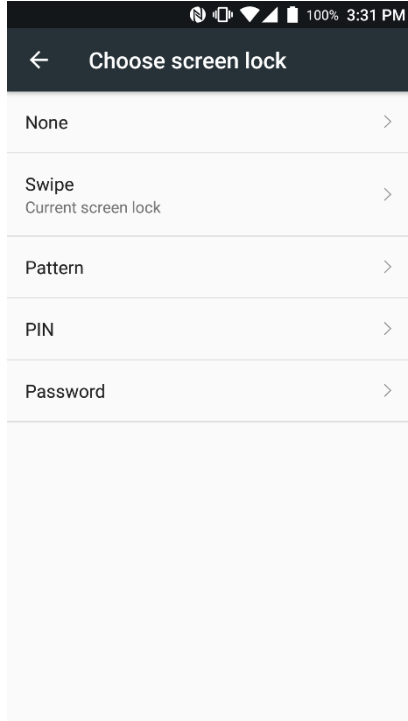

- None : PM45 screen unlock immediately
- Swipe : To unlock the screen, user should swipe the screen
- Pattern : To unlock the screen, user draw the pattern
- PIN : To unlock the screen, user should input the pin
- Password : To unlock the screen, user should input the password

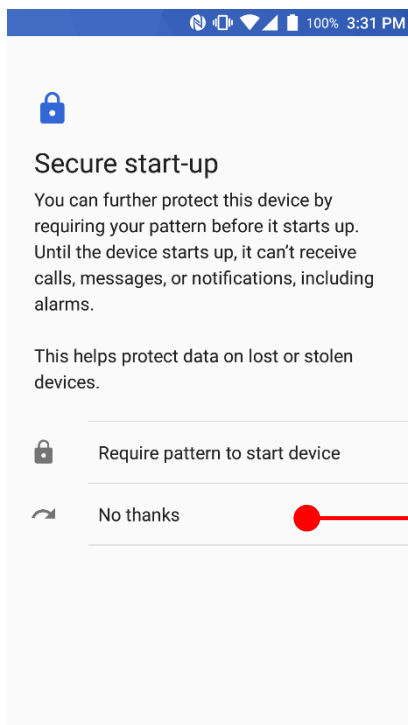



When you choose the Pattern, PIN or Password option, you can set secure start-up option. This function enables unlock the PM45 before bootup

If you don't want secure start-up option, please touch "No thanks"

Manage a display

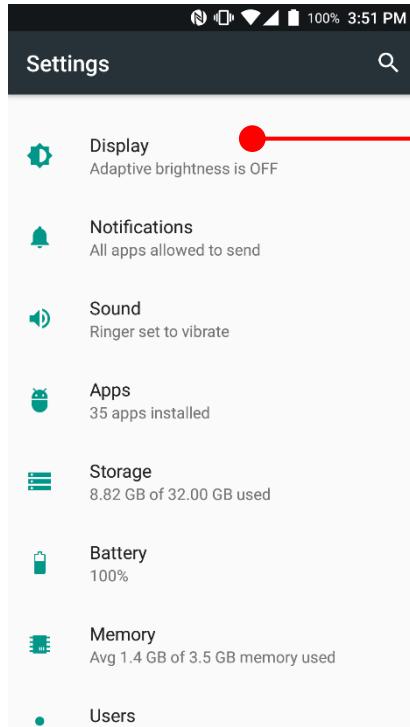
Learning the basics



Touch  "App drawer" icon →  "Settings" and then "Display"

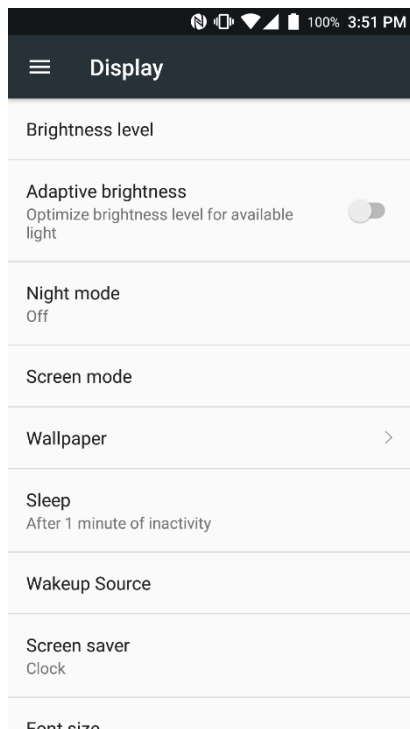

Brightness level :

This setting change the screen brightness level

Adaptive brightness :

By enable this option, PM45 adjust the screen brightness

Night mode :

Set screen color temperature (Warm level) of PM45

Screen mode :

Set overall color temperature and image mode of PM45

Manage a display

Learning the basics

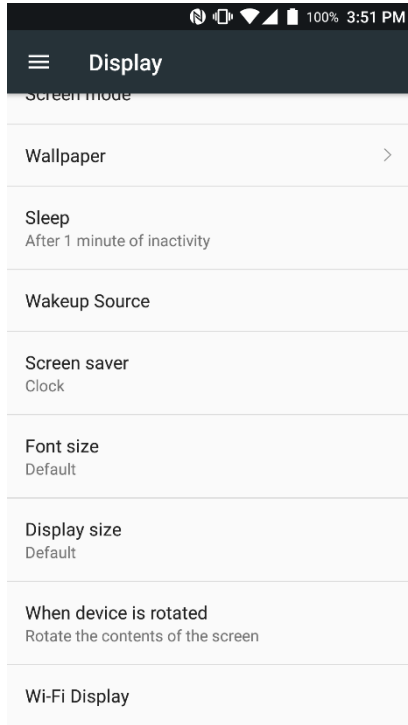

Font size : Set overall font size of PM45

Display size : Set overall font display amount of PM45

Manage a display

Learning the basics

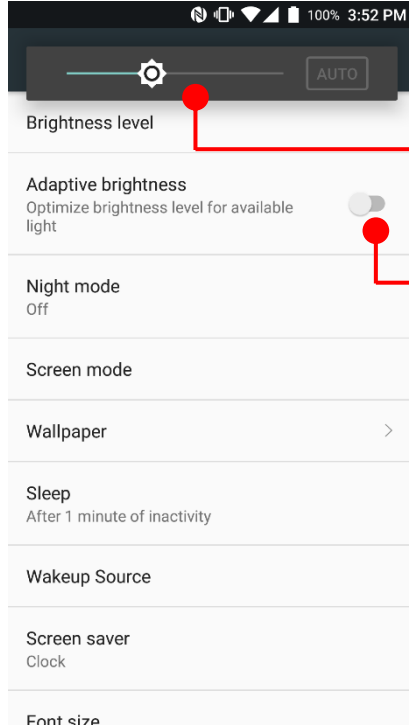

To change the brightness level, please adjust the slider

If you let PM45 auto adjust the brightness level, please touch “Auto” or enable “Adaptive brightness” option

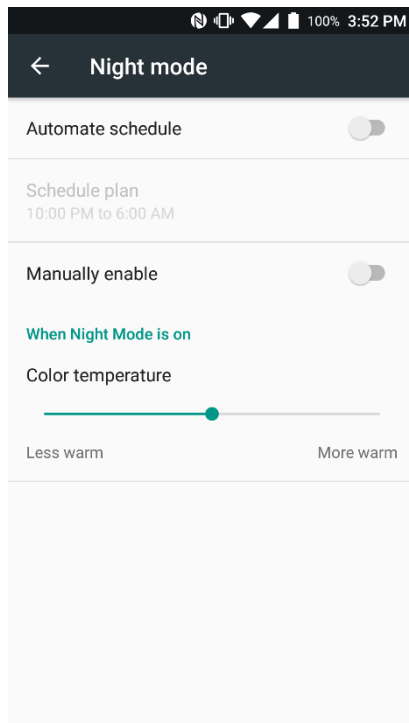

By setting this option, PM45 change warm level of color temperature

Most of usage is prevent eye fatigue during the night time or dark room

Manage a display

Learning the basics

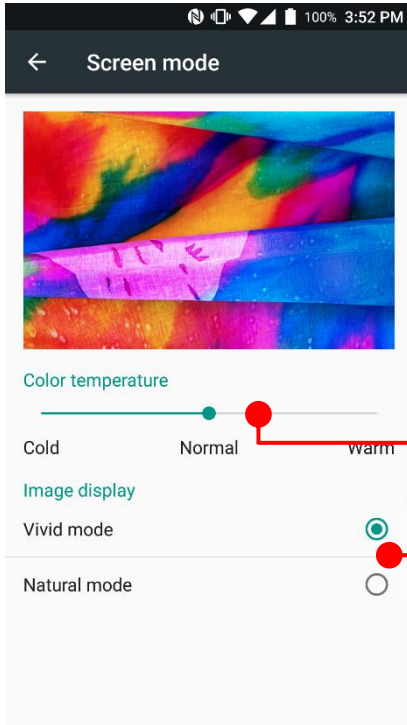

To change the overall color temperature of PM45, please adjust the slider

Select image's color displaying mode of PM45.



Change the overall font size of PM45. Please adjust the slider

Manage a display

Learning the basics

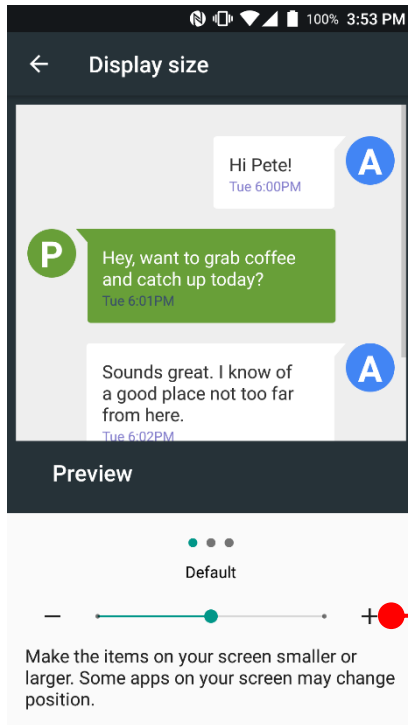

Change the amount of the display item of PM45. Please adjust the slider

Make a call

Learning the basics

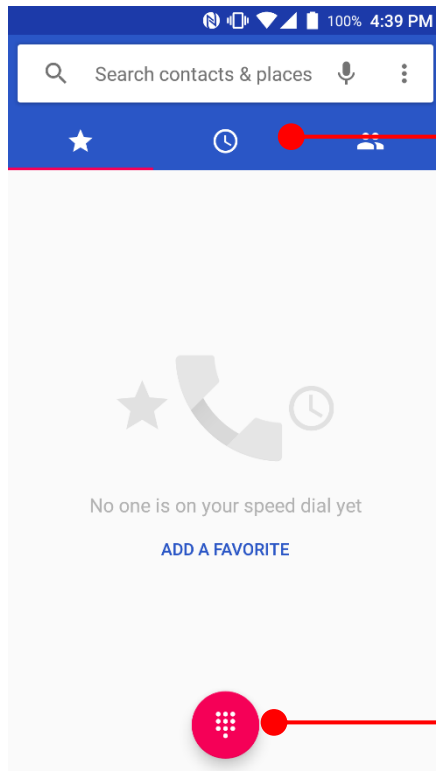

Touch  icon in the Favorite tray apps

Slide to access the **“FAVORITE”**, **“RECENTS”** and **“CONTACTS”**.

- To make a call from recent call list or missed call, select **“RECENTS”** tab
- To make a call from your contact list, select **“CONTACTS”**

Touch to use a dialer

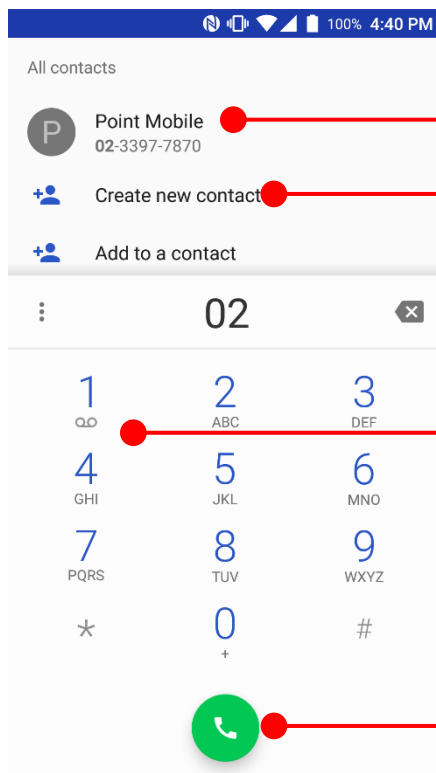

Suggested phone number(s)

Phone number can be saved to **“CONTACTS”**

Touch and hold the dial pad **#1**, to access voicemail.

Touch to place a call

Make a call

Learning the basics

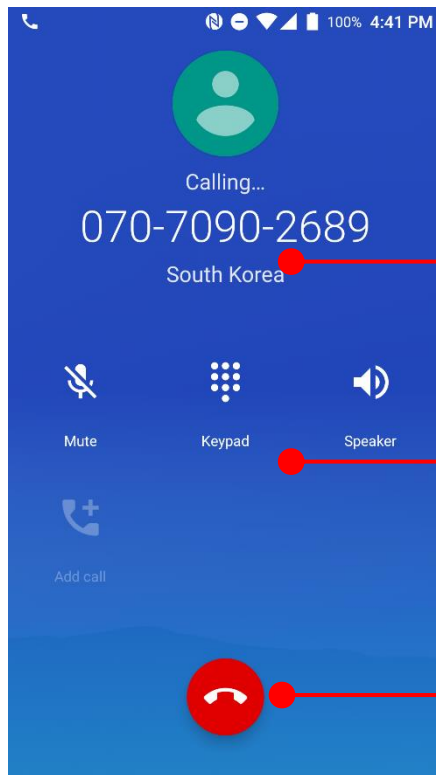

Calling information

- Mute : Touch to mute the mic
- Keypad : Touch to dial during a call
- Speaker : Touch to make a speaker phone call

Touch to end a call

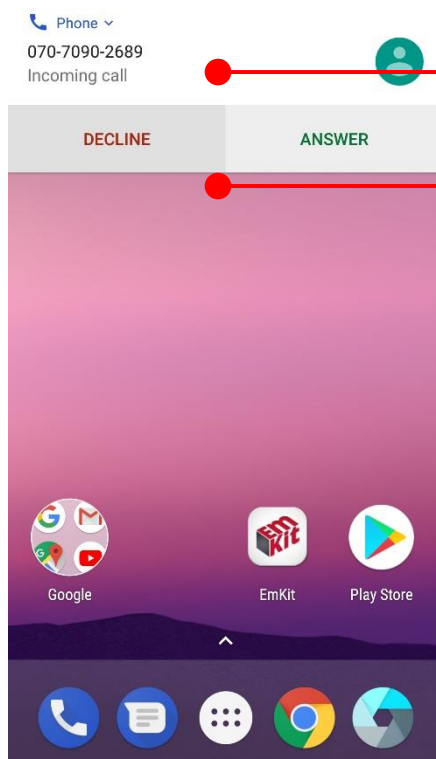

Caller information

- Decline : Touch to refuse a call
- Answer : Touch to answer a call

Tip: To mute the ringtone volume of an incoming call, keep press the “Volume down” key or turn your PM45 over.

Add to a contact

Learning the basics

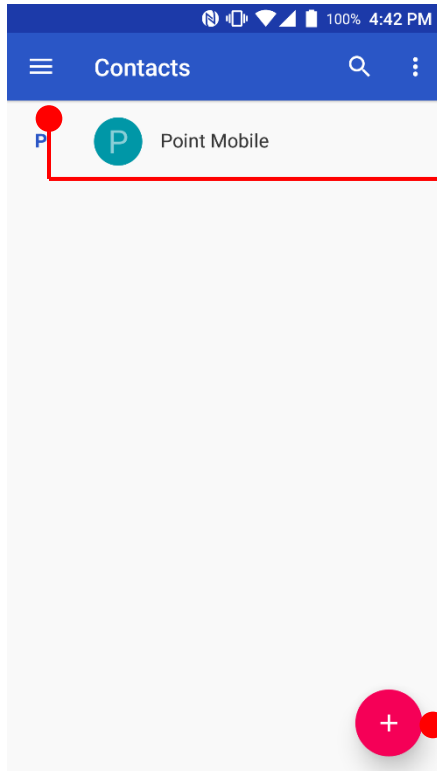

Touch  icon in the Favorite tray apps

Touch to see Contacts options

Touch to add a new contact

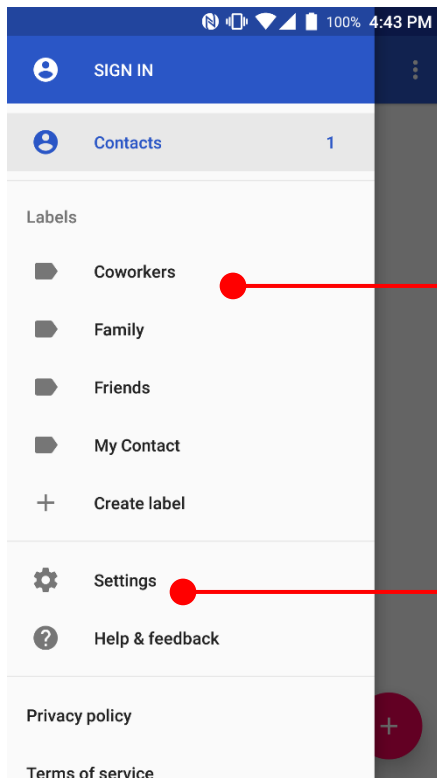

Labels which you set in your google account

Touch to set more detail settings

Add to a contact

Learning the basics

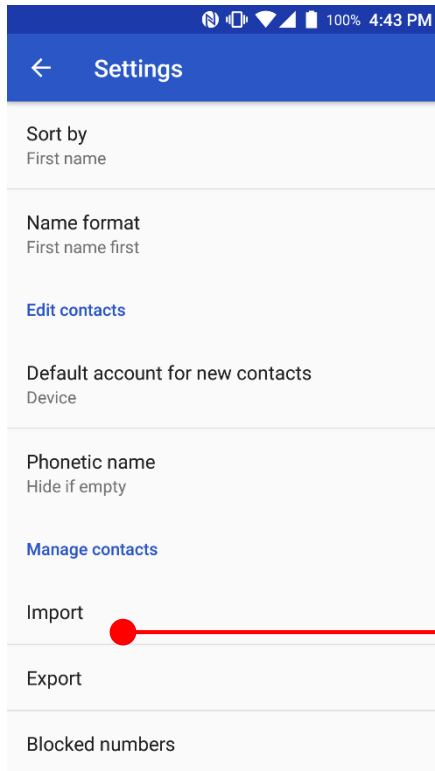

Touch to import contact information in your SIM card

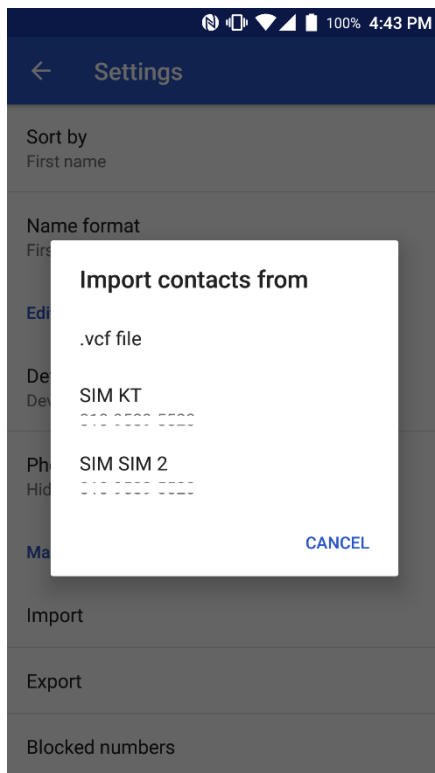

Add to a contact

Learning the basics

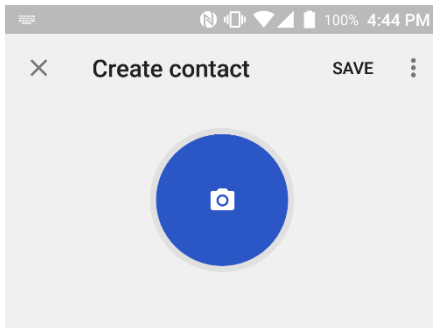

Device — Save location for the new contact

First name — Input Contact name, phone numbers and other information in the form

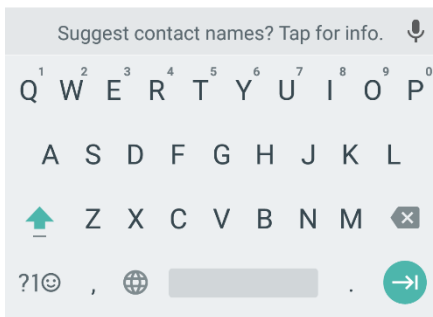

Touch to import contact information in your SIM card

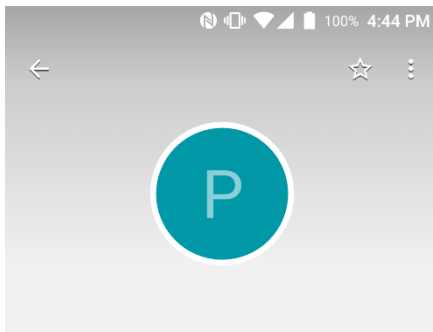

Point Mobile

Call Text Set up

02-3397-7870
Mobile

Recent

See your history together
Events and messages

— Touch to edit contact information

Add to a contact

Learning the basics

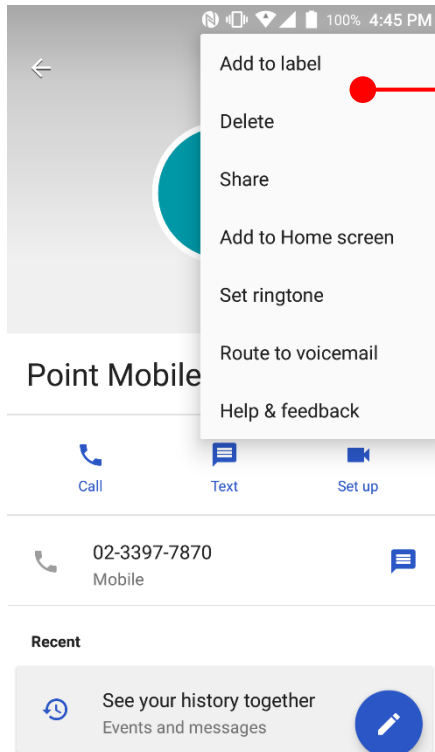

Touch an option you would like to edit or change

Send a message

Learning the basics



Touch  icon in the Favorite tray apps



Once you start a new conversation, you'll see it listed here



Touch to send a new message

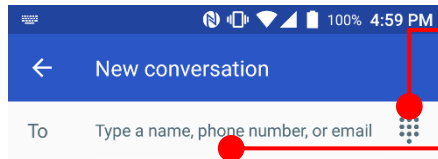

Touch to use a dialer

Touch to type a name, phone number or email

 Start group conversation

P
 Point Mobile
 0233977870 Mobile

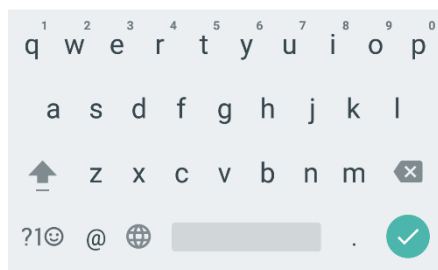

Send a message

Learning the basics

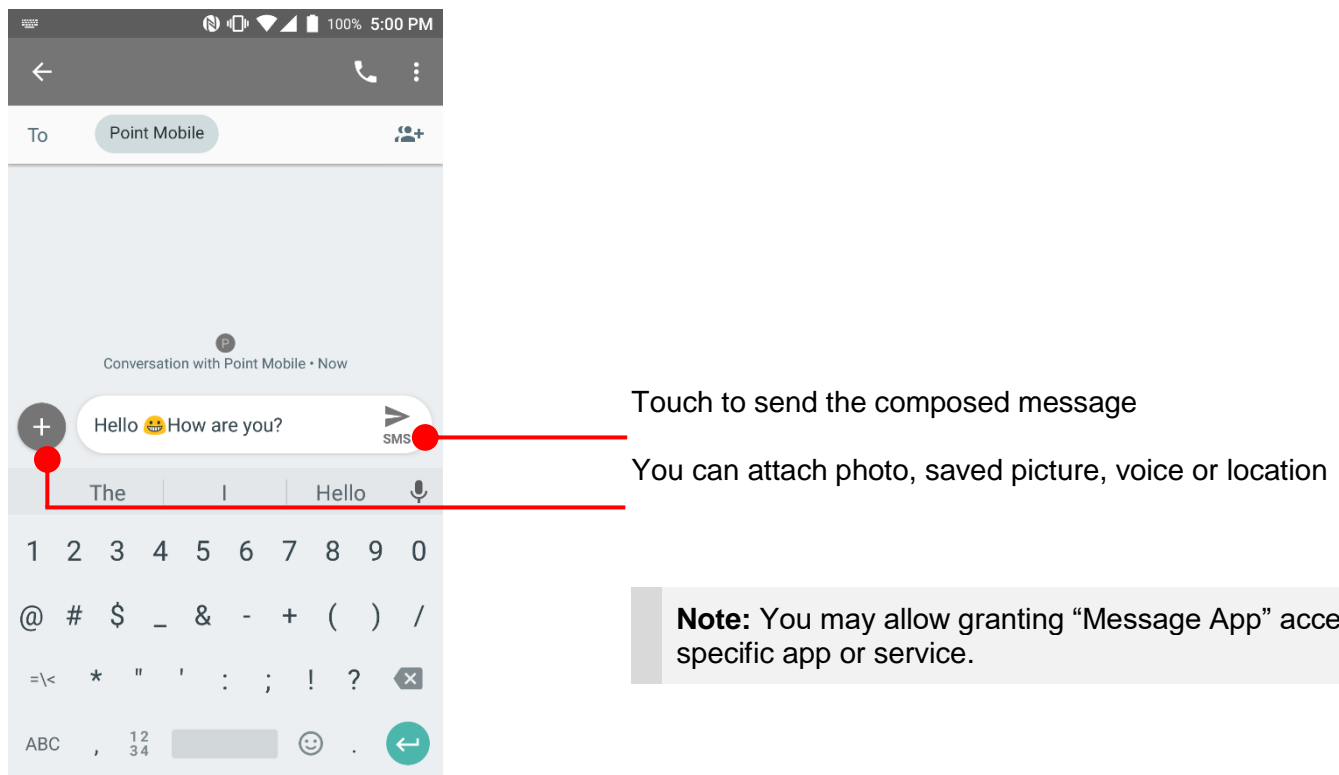
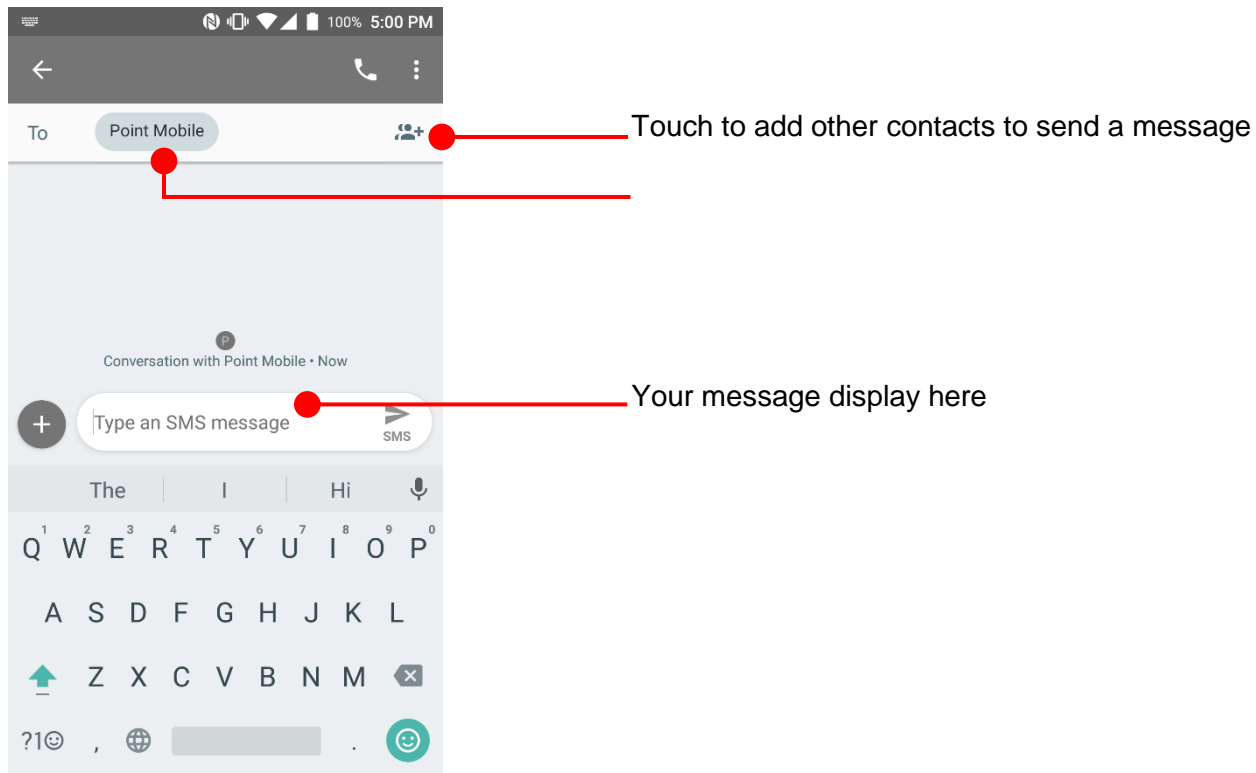

Note: You may allow granting “Message App” access specific app or service.

Send a message

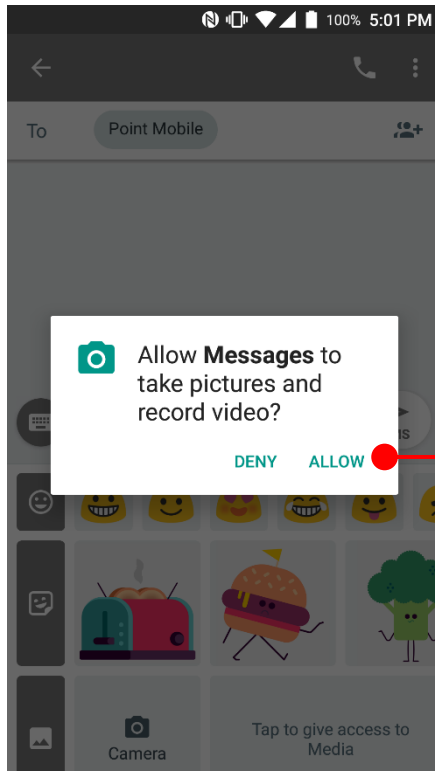

Learning the basics

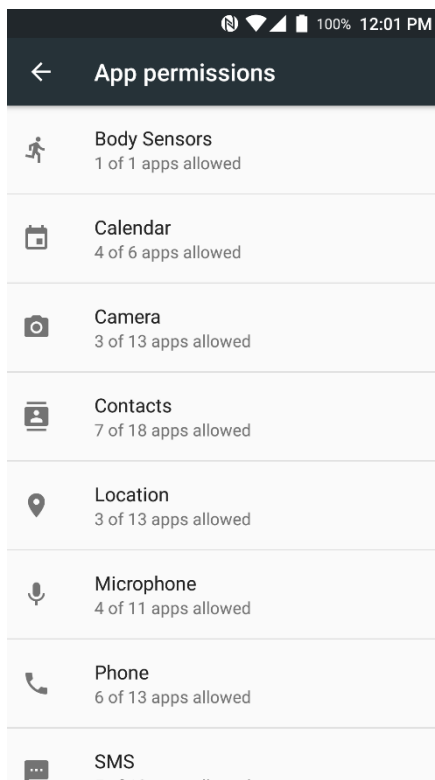

Android ask a grant app's specific permission access for first time use. To send a photo or a saved media file or a voice recode file or a location, please touch **ALLOW**







You can review granted permission info at

Touch  "App drawer" icon →  "Settings" → Apps → Configure apps  → App permissions

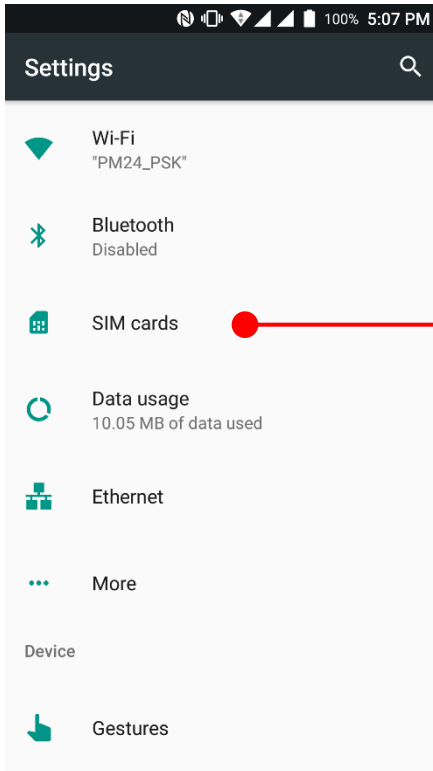
Change a SIM card settings

Learning the basics



Touch  "App drawer" icon →  "Settings" and then  "SIM cards"

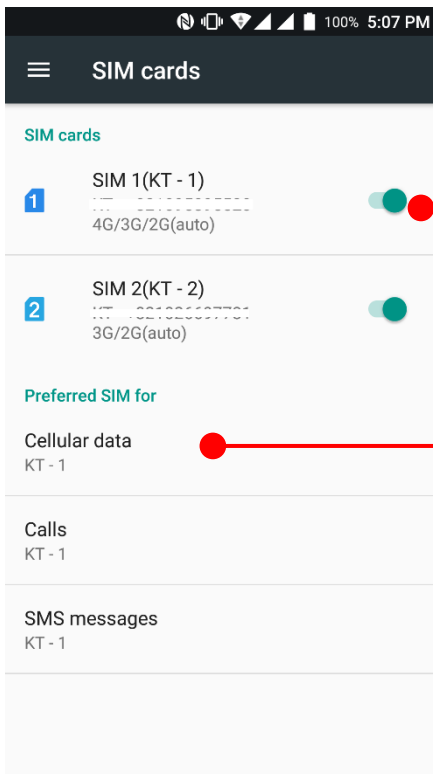

Touch to enable/disable using a SIM card (PM45 is Dual SIM Dual Standby model)

Currently set SIM card information
Touch to change each option

Change a SIM card settings

Learning the basics

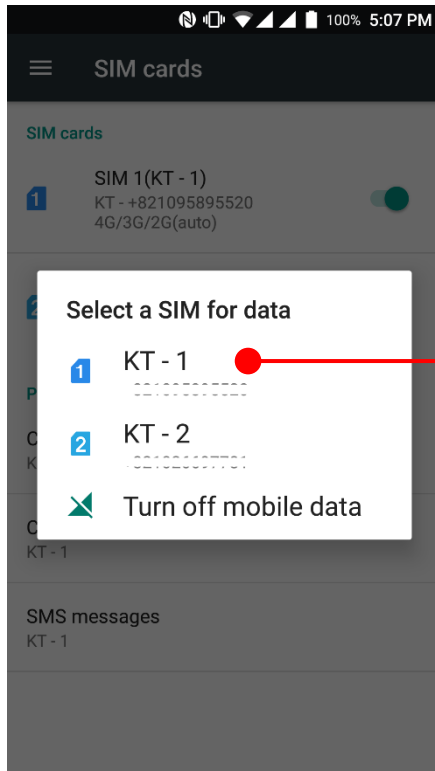

Select SIM card for mobile data or turn off mobile data

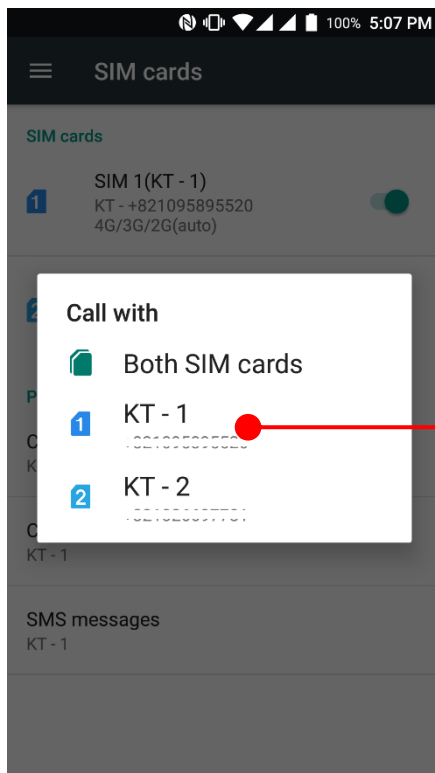

Select SIM card for calling. You can select Both SIM cards

Change a SIM card settings

Learning the basics

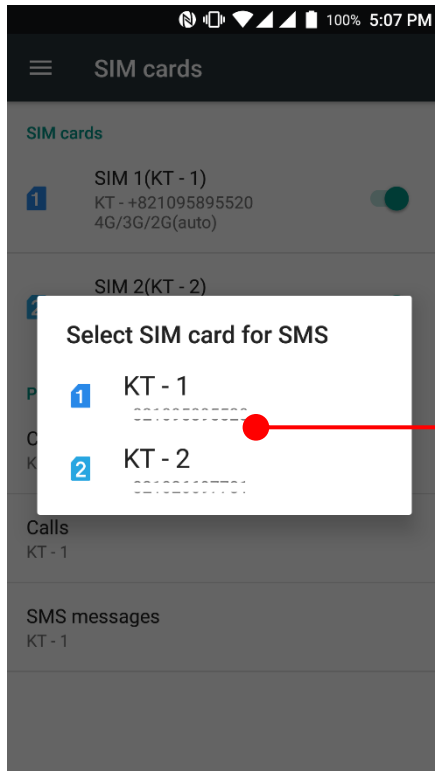

Select SIM card for messaging. You can select Both SIM cards

Connect to your Wi-Fi network

Learning the basics

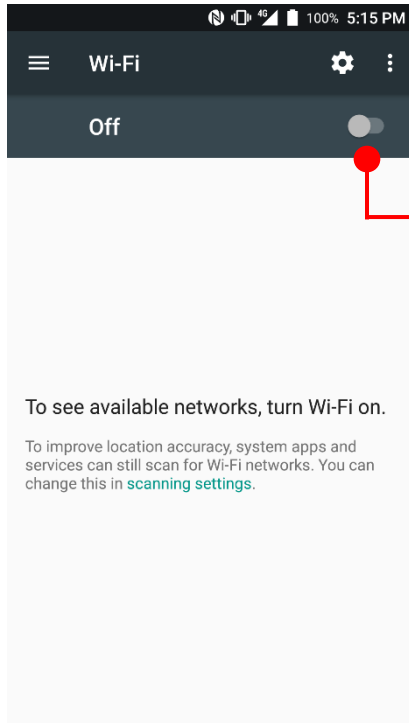

Touch
“Wi-Fi”



“App drawer” icon →



“Settings” and then

Touch to turn On/Off the W-Fi

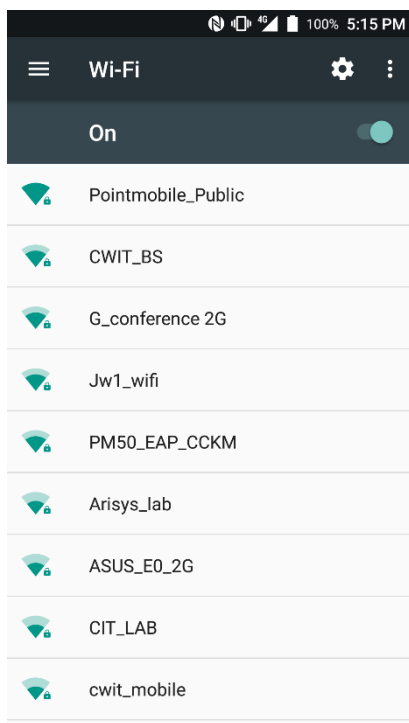

You can see nearby Wi-Fi network. Each AP's SSID information listed by signal strength



Icon means: Open Wi-Fi network. You don't need to enter the password



Icon means: Secured Wi-Fi network. To connect this Wi-Fi, you need to enter the password

Connect to your Wi-Fi network

Learning the basics

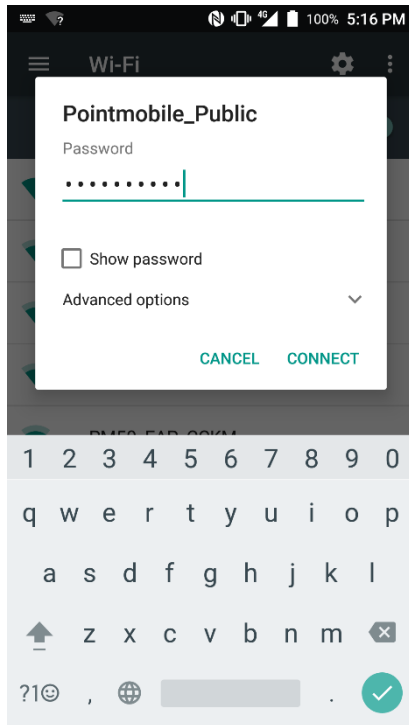

Touch SSID, which you want to connect.
To connect to the secured Wi-Fi network, enter the password

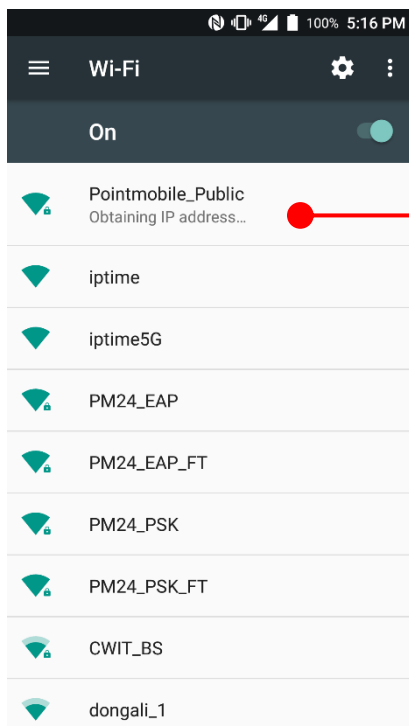

Your PM45 is obtaining the IP address from the selected AP

Make a Wi-Fi hotspot

Learning the basics

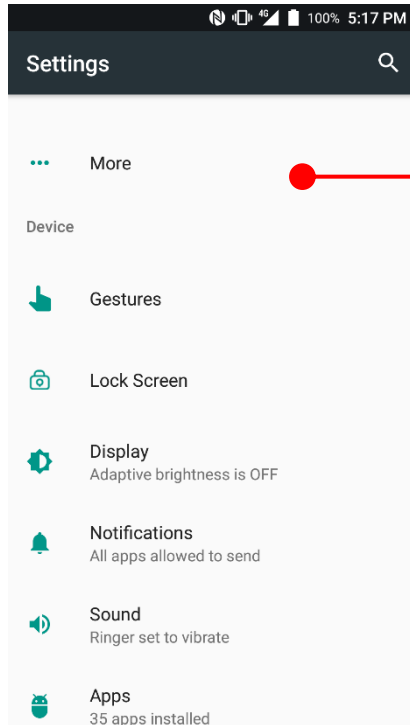

Touch
"More"



"App drawer" icon →  "Settings" and then

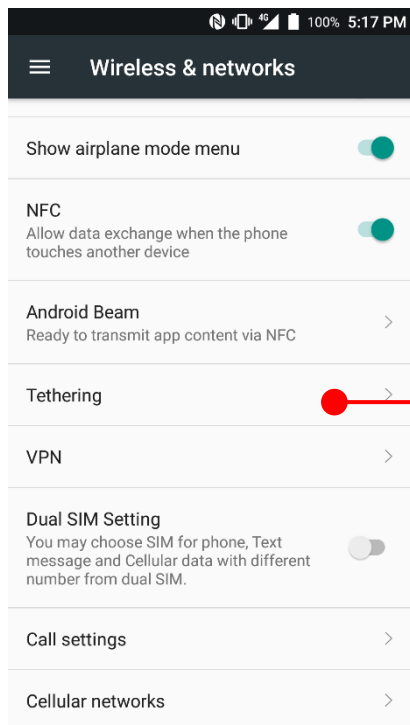

Touch "Tethering"

Make a Wi-Fi hotspot

Learning the basics

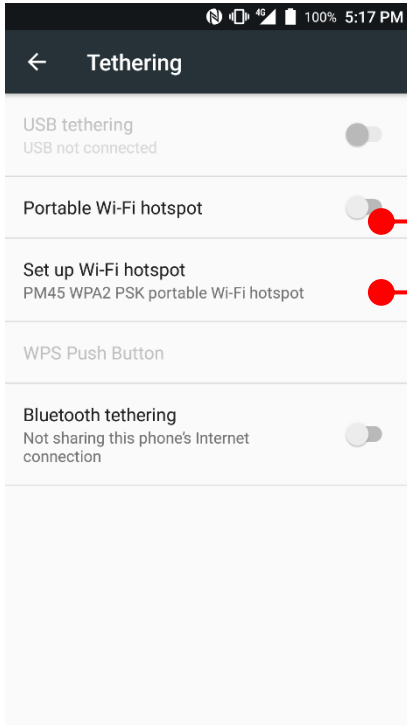

Touch to turn On/Off the W-Fi hotspot

Touch to set Wi-Fi hotspot setting

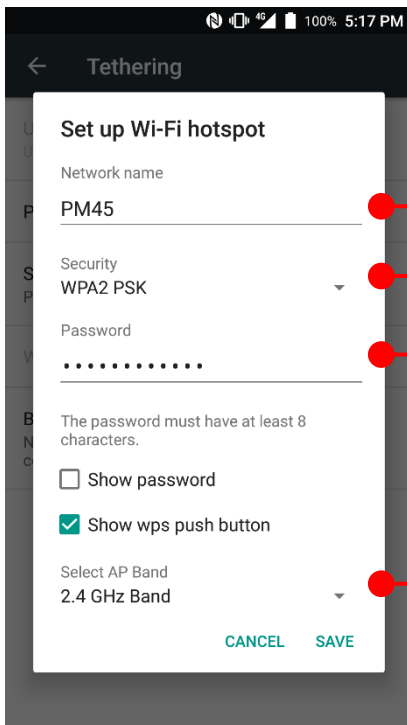

Set hotspot name

Set hotspot security type : None / WPA2PSK

Set password for hotspot

Set hotspot band : 2.4GHz / 5GHz

Make a Wi-Fi hotspot

Learning the basics

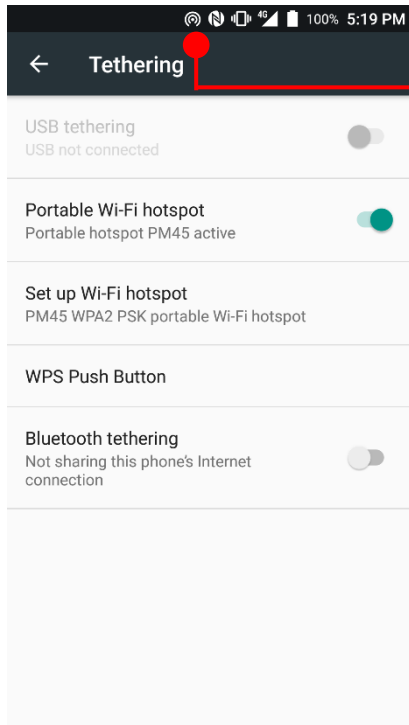



When hotspot is ready, you will see this icon

Connect with Bluetooth device

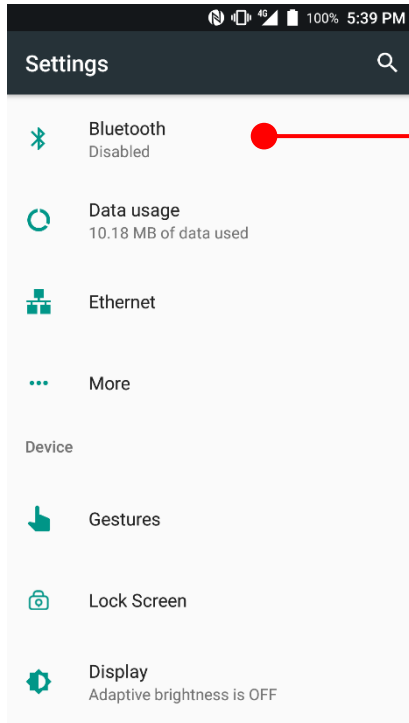
Learning the basics



Touch  "App drawer" icon →  "Settings" and then "Bluetooth"

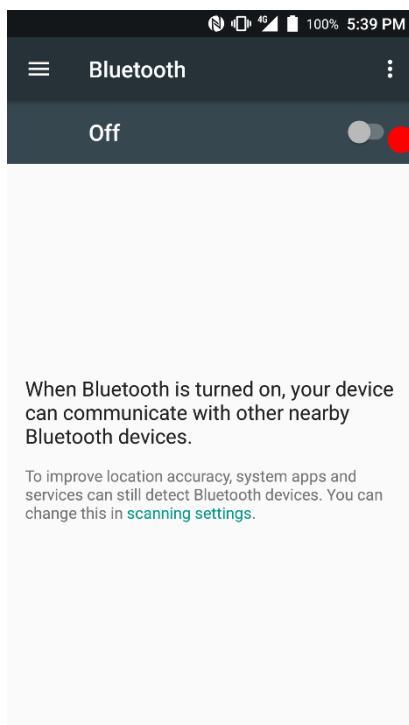

Touch to turn On/Off the Bluetooth

Connect with Bluetooth device

Learning the basics

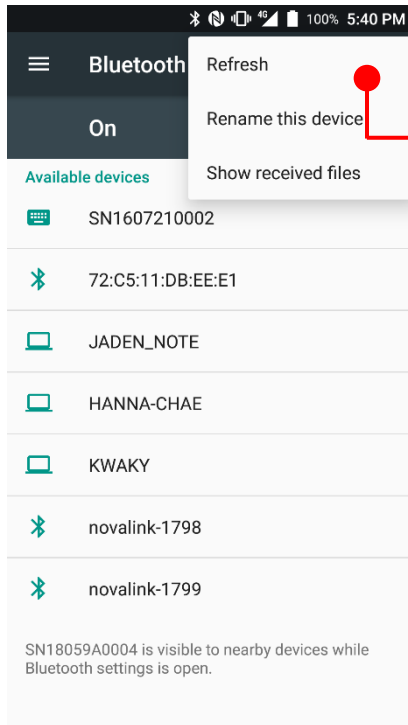

PM45 will list up nearby Bluetooth devices. If you don't find the device which you want to pair, touch option icon  in top-left corner and touch "Refresh"

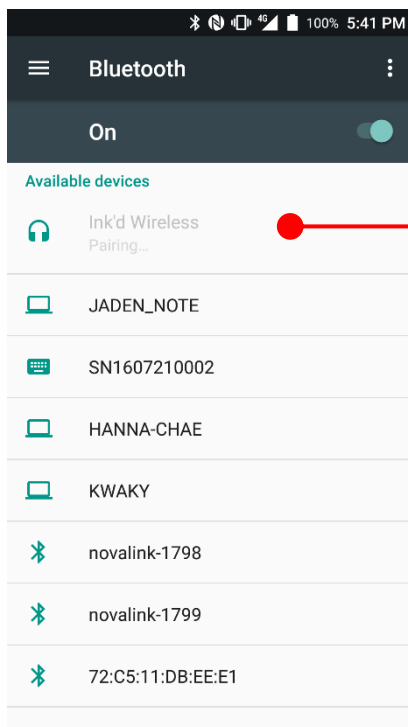

By touching the device name in the list, PM45 start to pair with Bluetooth device. (You may input the password)

Connect with Bluetooth device

Learning the basics

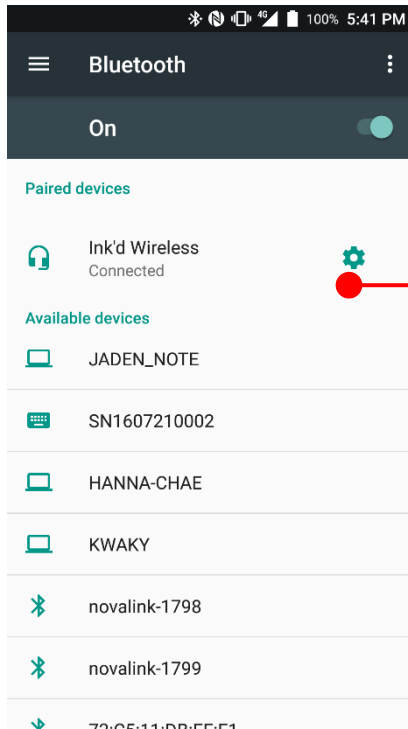

Bluetooth device is connected with PM45.
Touch ⚙ icon for advanced setup

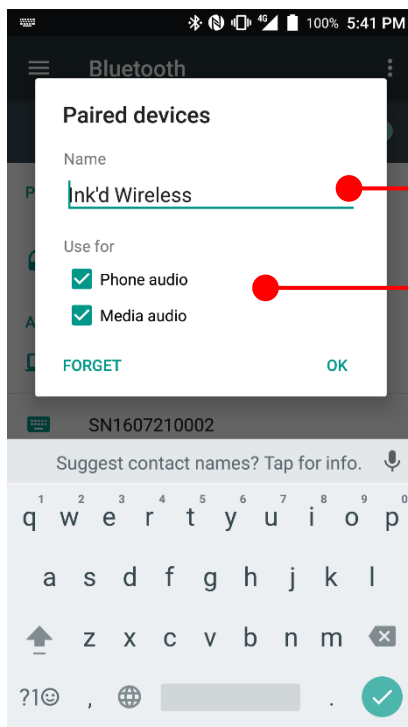

Set Bluetooth device name

Set Bluetooth device permission (This option could be various by types of the Bluetooth device)

Use a Camera

Learning the basics

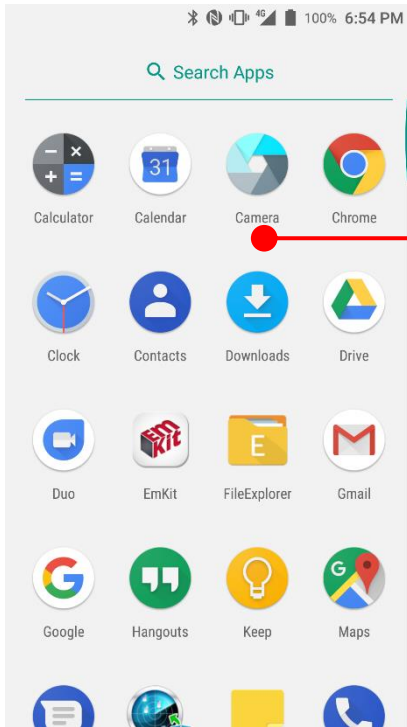

Touch icon in the favorite tray or
 “Camera” icon

“App drawer” icon →

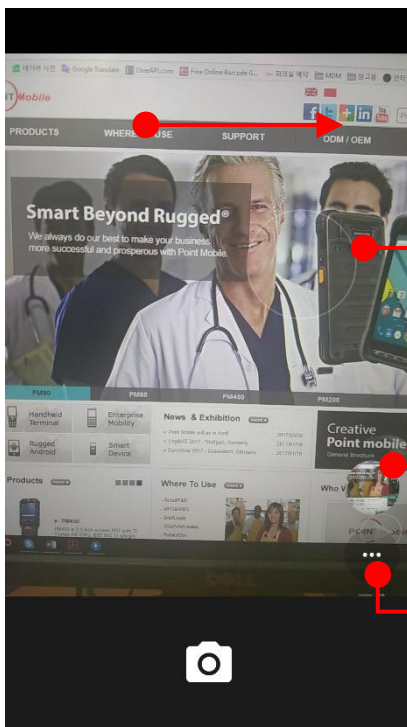

Swipe to change the Camera / Video mode or Settings

Touch for auto focusing the target area

Saved image or video

Camera or Video menu

Use a Camera

Learning the basics

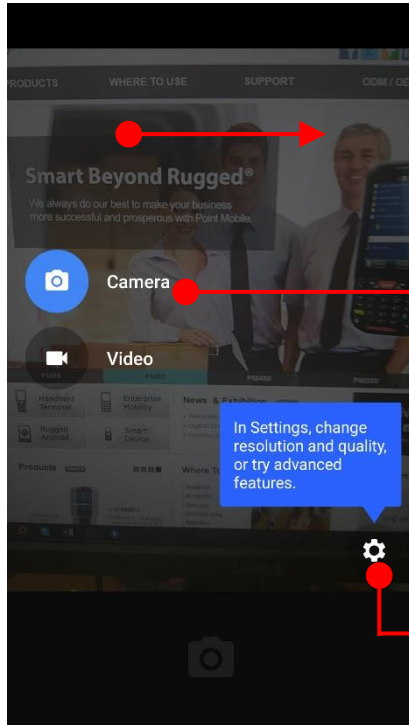

Swipe to enter the menu

Touch to change the Camera mode / Video mode

Touch to change resolution and image quality

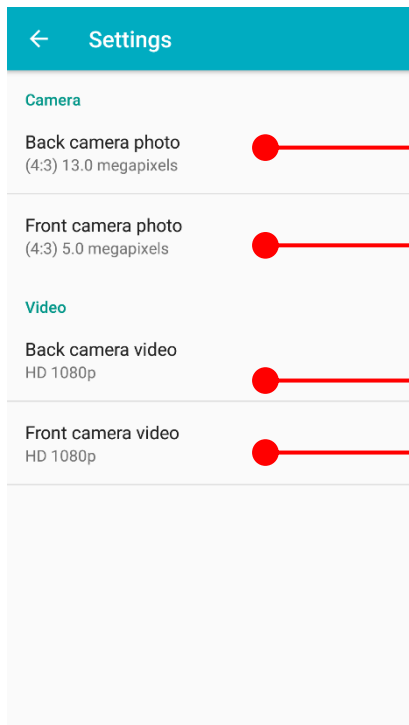

Set rear camera image saving quality

Set front camera image saving quality

Set rear camera video saving quality





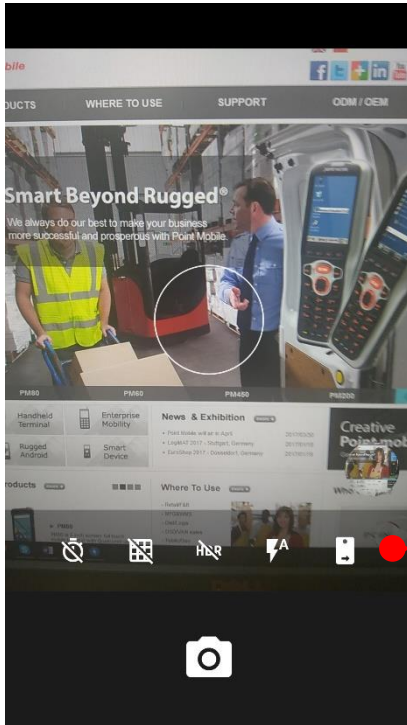

Set front camera video saving quality

Use a Camera

Learning the basics





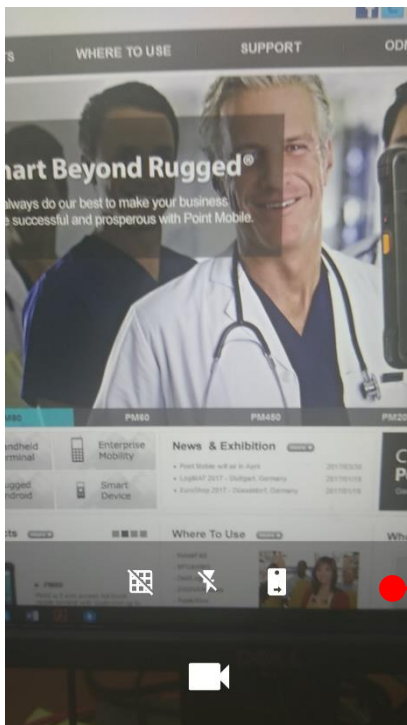

Camera Menu

-  Timer option : 3seconds / 5seconds
-  Grid On / Off
-  HDR option
-  Flash option : Auto flash / Flash / No flash
-  Change Rear / Front camera
-  Take a photo. You may press volume up or down key





Video Menu

-  Grid On / Off
-  Flash option : Auto flash / Flash / No flash
-  Change Rear / Front camera
-  Take a video

Manage files and folders

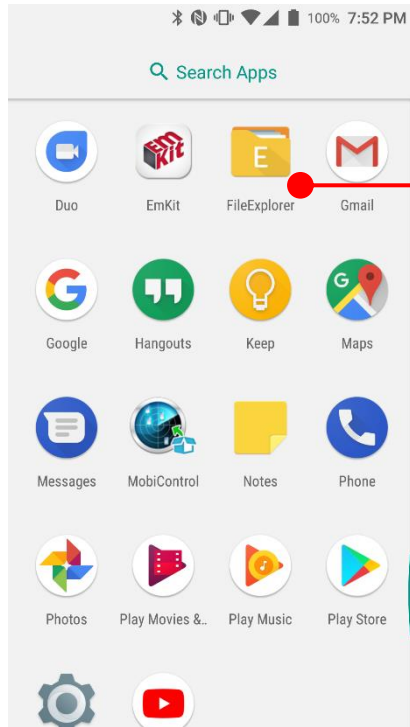
Learning the basics



Touch  "App drawer" icon and then  "File Manager"

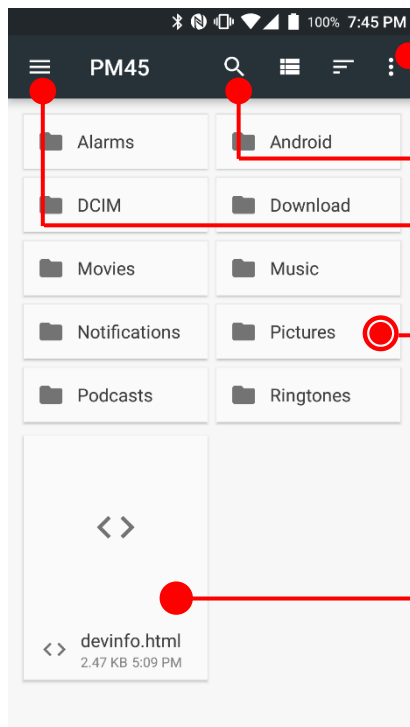

Touch for advanced menu

File search

Select storage

Long tap to select a file or folder

Touch to navigate folder / open the file or install an apk file

Manage files and folders

Learning the basics

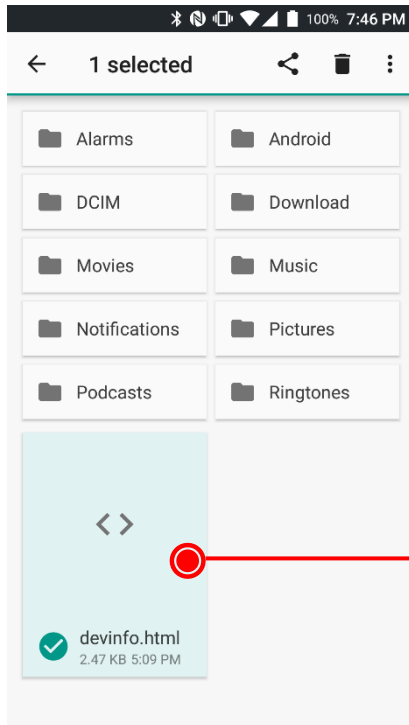

Long tap action

Long tap the file and touch option icon  in top-left corner

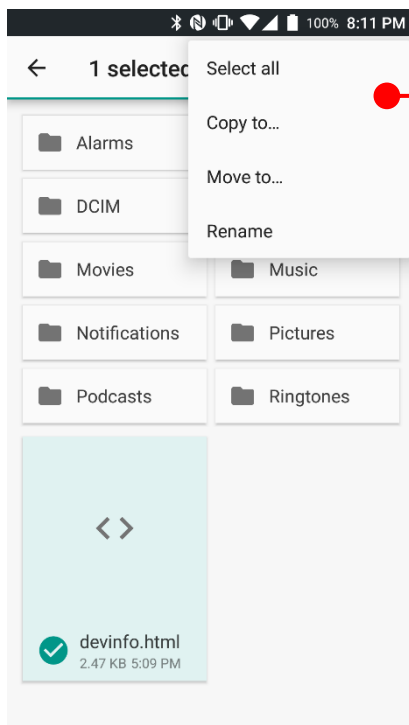

Now you can copy the file, move to specific folder or rename the file or folder

Manage files and folders

Learning the basics

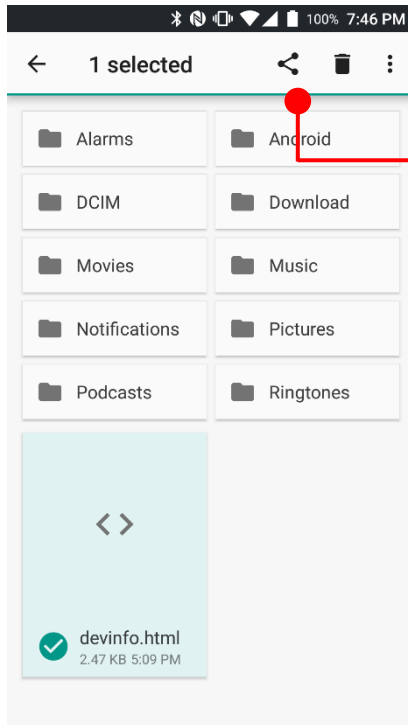

Share a file

Long tap the file and touch share icon  in the menu

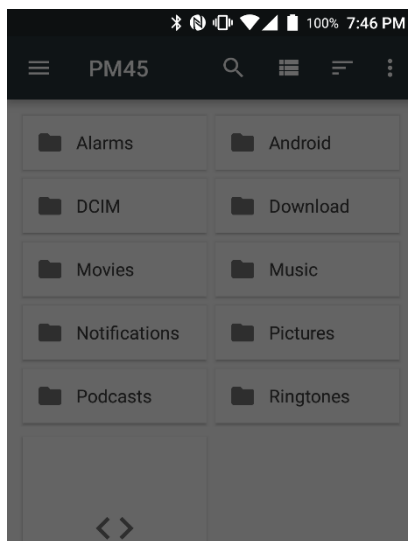

Share via



Now you can share selected file to nearby device or attach to Gmail or upload to Google Drive. Manual describe Android Beam sharing via NFC

Manage files and folders

Learning the basics

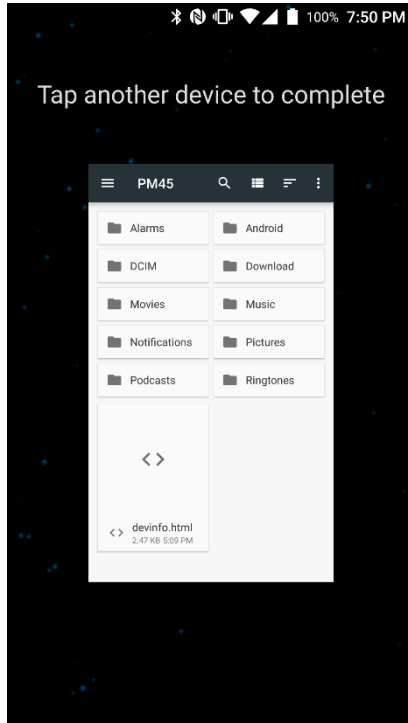

Now tag another device to PM45's battery cover. PM45 will transfer the file

Note: Please make sure NFC is activated. NFC antenna is in the battery cover. Please lock the battery cover firmly

Manage files and folders

Learning the basics

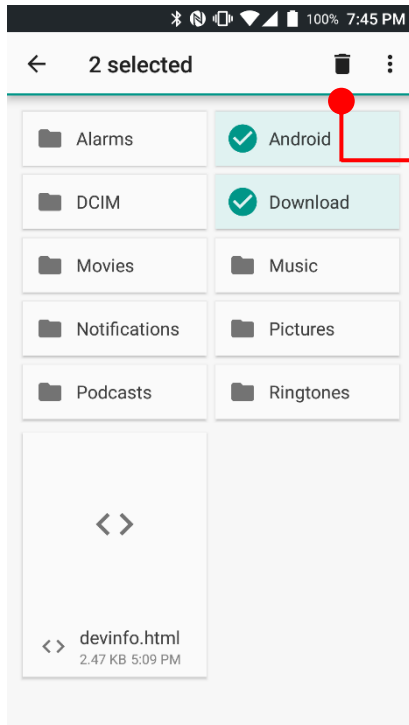

Delete a file

Long tap the file and touch delete icon  in the menu

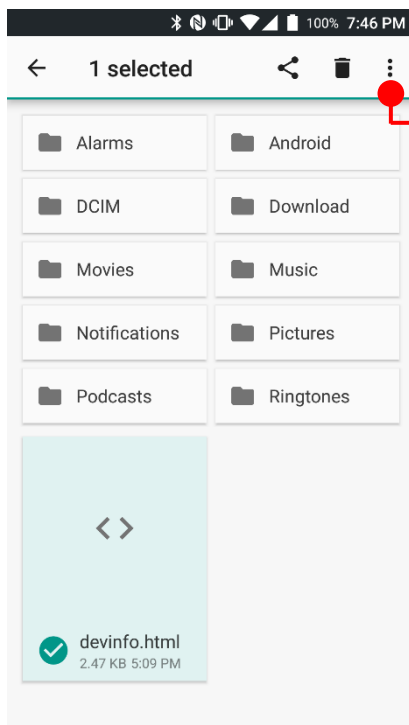

Copy or move a file

Long tap the file and touch option icon  in top-left corner

Manage files and folders

Learning the basics

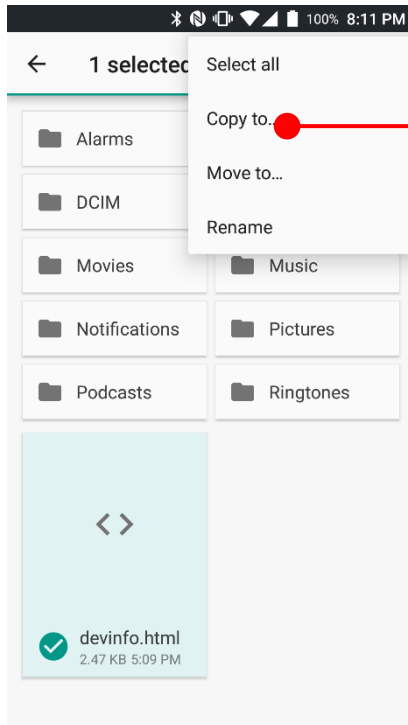

Touch "Copy to..." or "Move to..." in the menu

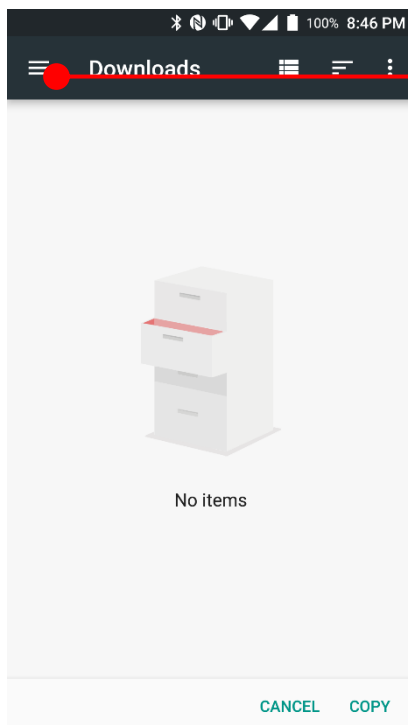

Touch menu icon ≡ to navigate file location

Manage files and folders

Learning the basics

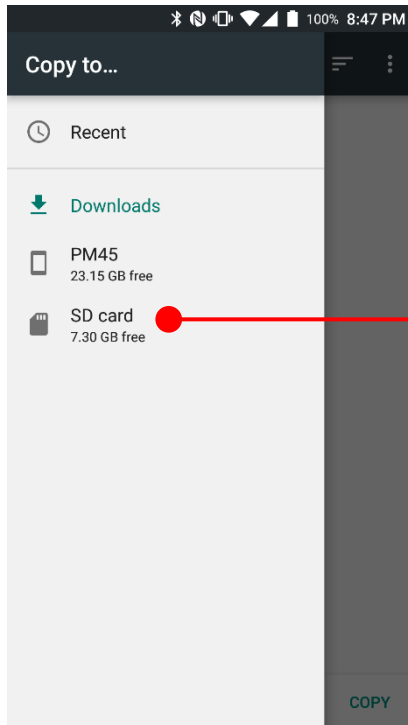

Touch the storage where copy or move to

Note: Please format the SD card as FAT32 and make sure set the label as below screenshot from the computer

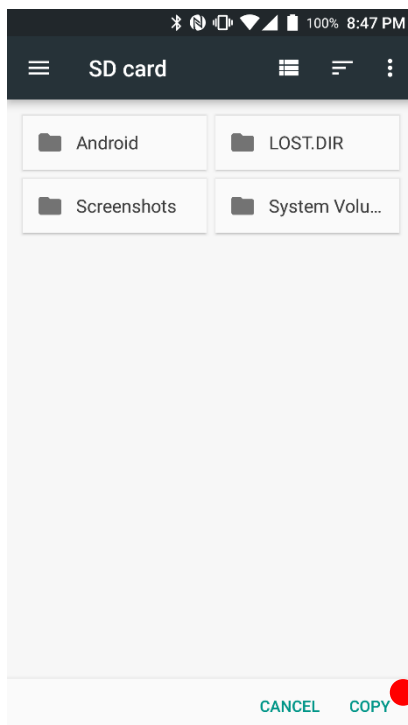
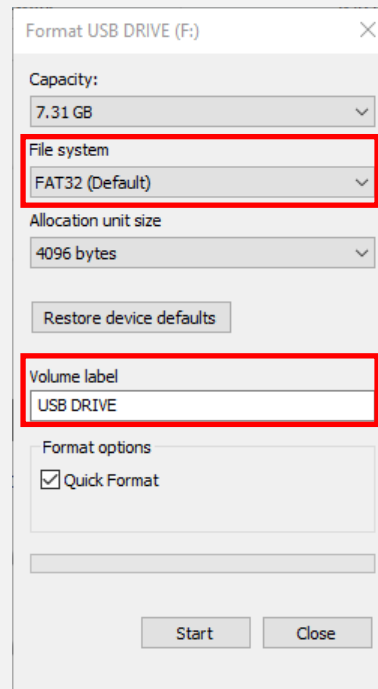

Touch "Copy"

MTP connection with PC

Learning the basics

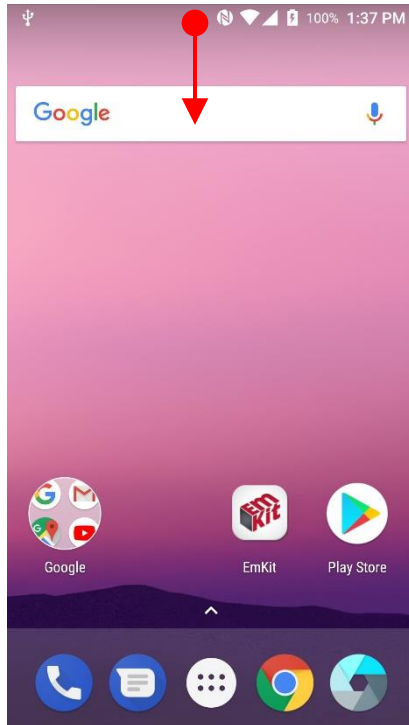

To browse files and folder in the PM45 in your PC, please change USB connect option

Scroll down the notification panel

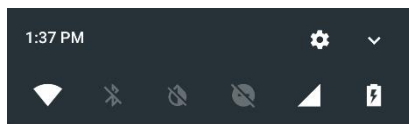

Android System
USB charging this device
Tap for more options.

Touch USB connect option

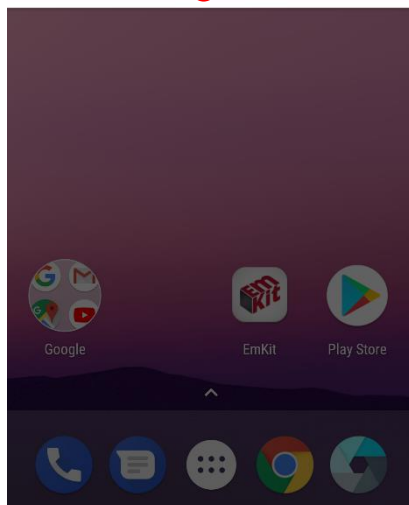

MTP connection with PC

Learning the basics

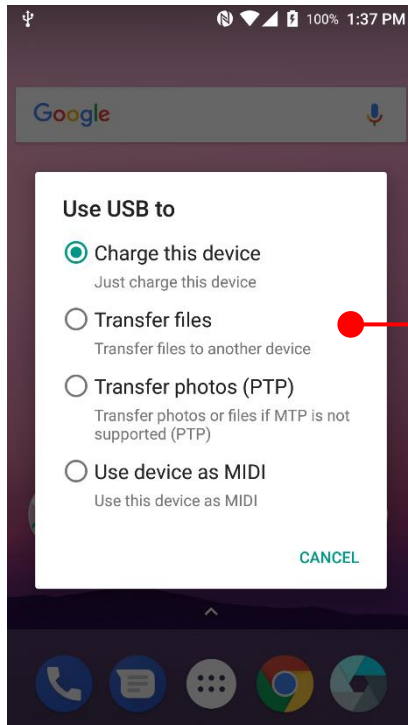

Change option to "Transfer files" from "Charge this device"

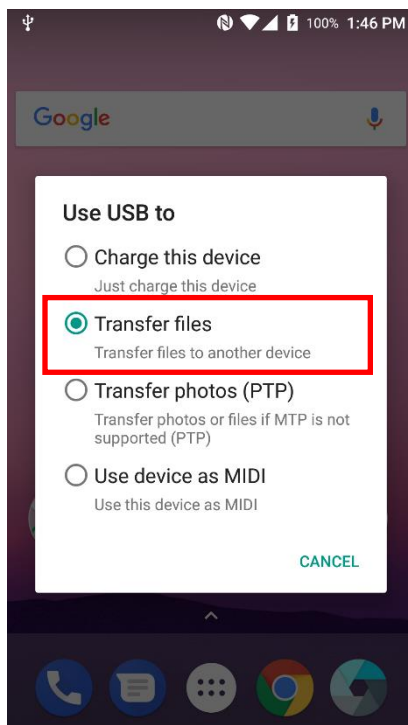

Now your PC recognize PM45 as MTP device

MTP connection with PC

Learning the basics

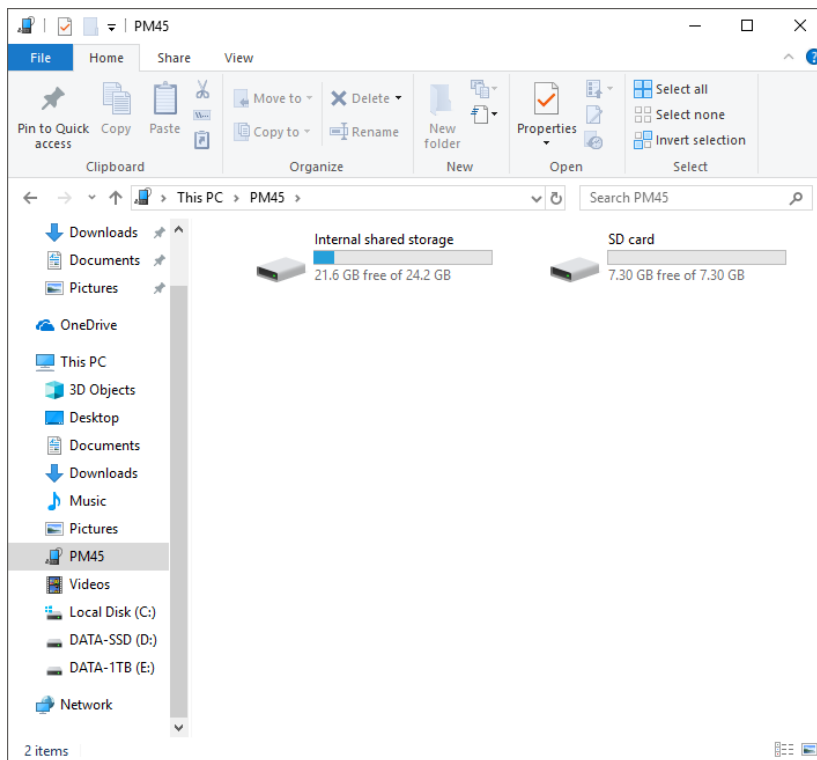
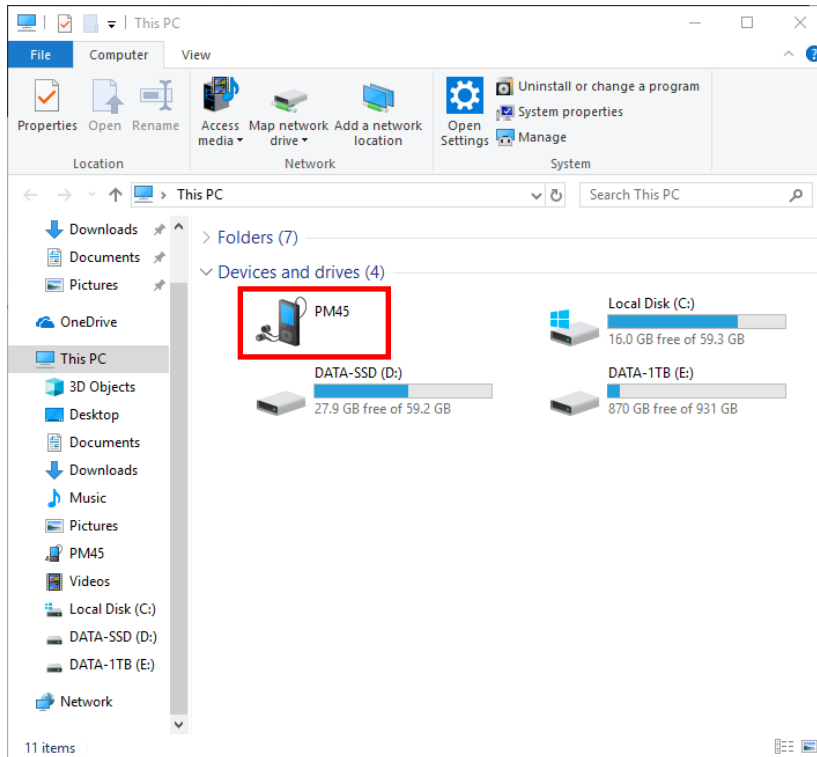



Change a Touch Sensitivity

Learning the basics

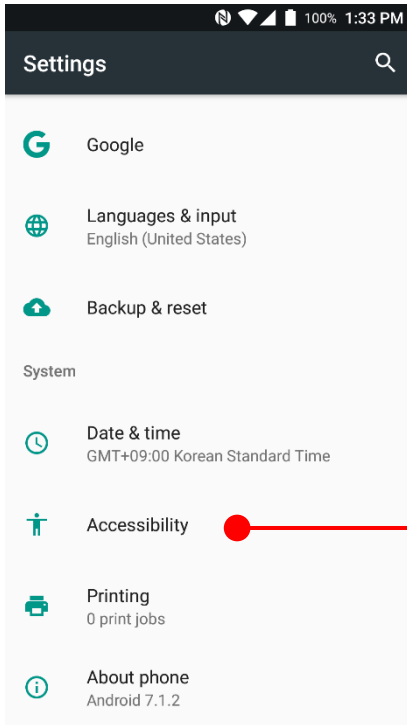
PM45 support touch sensitivity change option



Touch  "App drawer" icon →  "Settings" and then "Accessibility"

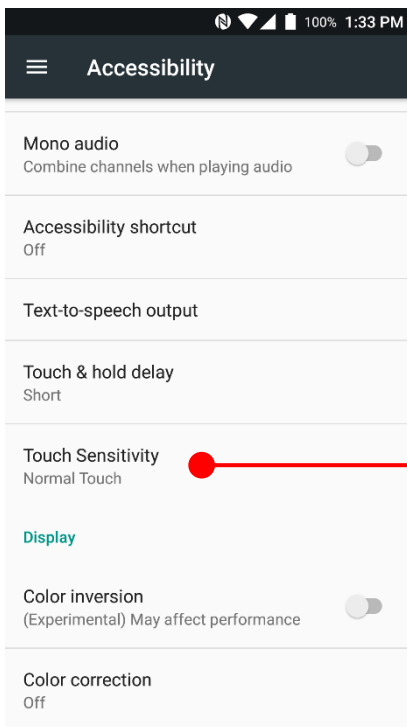

Touch "Touch Sensitivity"

MTP connection with PC

Learning the basics

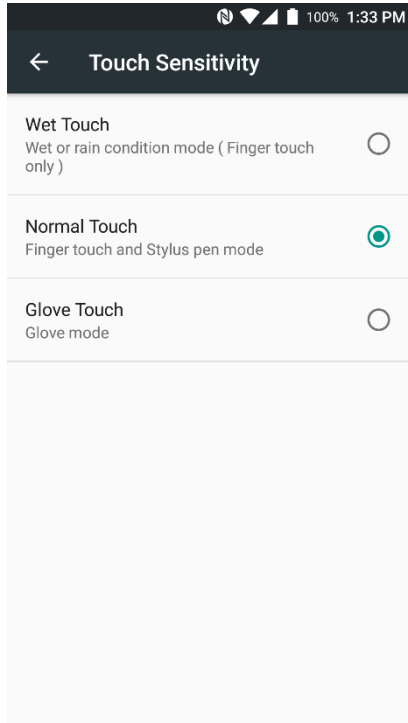

Default setting is Normal Touch. Please change sensitivity option for your usage or environment

Use a Google Assistant

Learning the basics

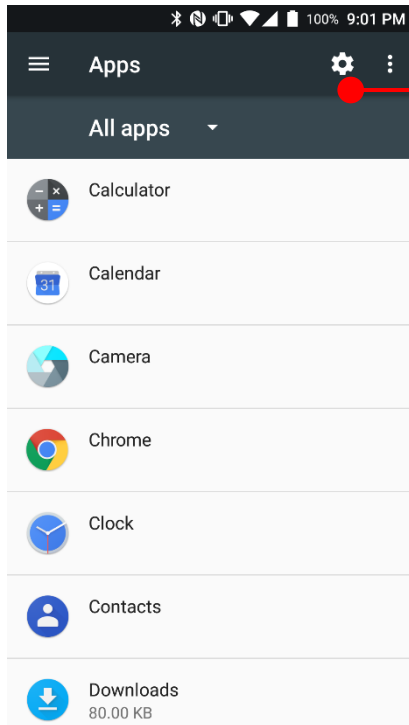

Touch  icon for app configuration change

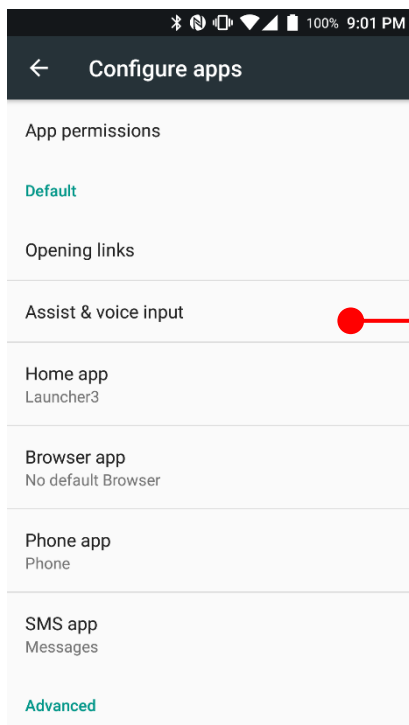

Touch Assist & voice input

Use a Google Assistant

Learning the basics

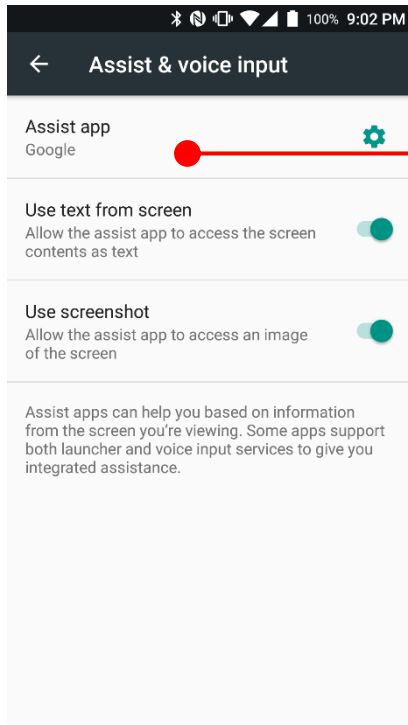

Make sure "Google" is selected

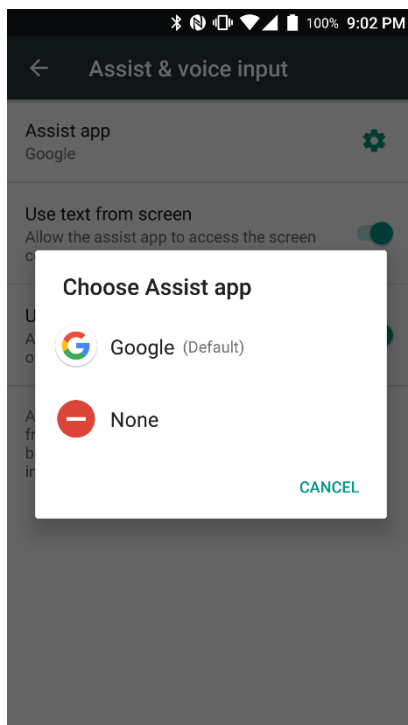

Use a Google Assistant



Learning the basics

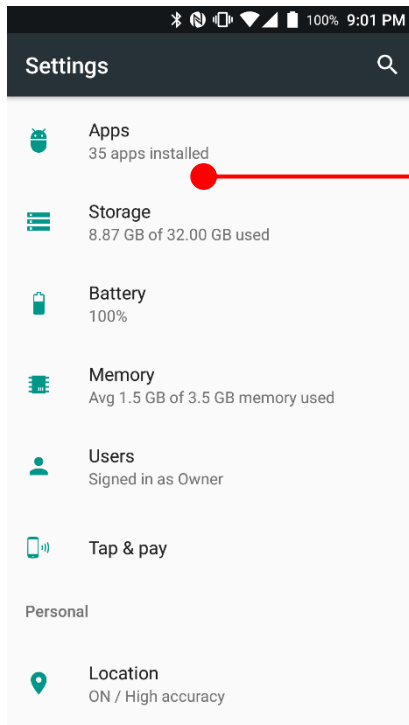

Touch and hold the home button key to use Google Assistant function





If Google Assistant doesn't work, please try followings

Touch  "App drawer" icon →  "Settings" and then "Apps"

Use a Google Assistant

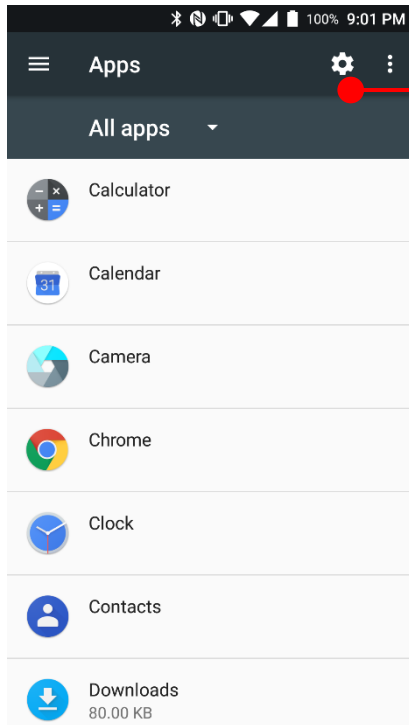
Learning the basics



Touch  icon for app configuration change

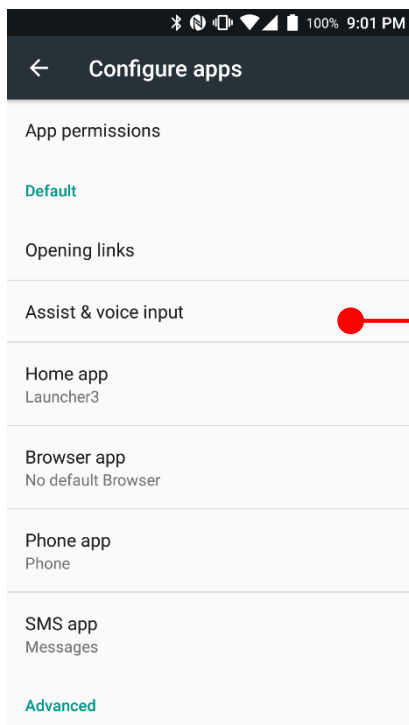

Touch Assist & voice input

Use a Google Assistant

Learning the basics

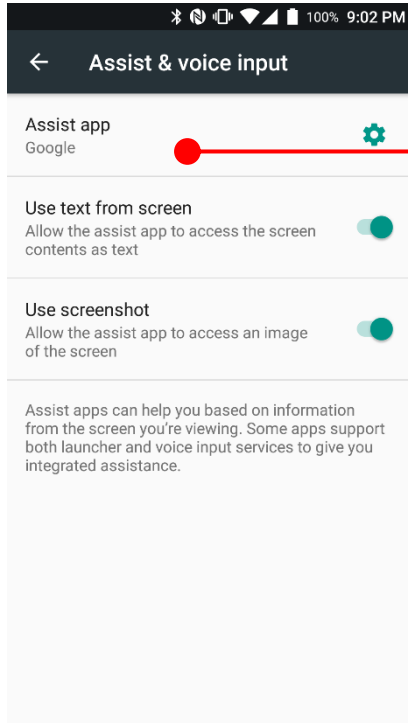

Make sure "Google" is selected

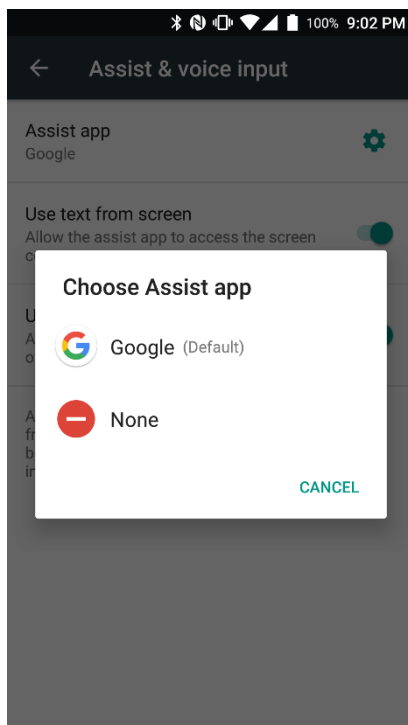

OS Image update from a Storage

OS Update

To update OS image, copy or place OS image file into the root folder of “Internal Storage” or “External Storage”

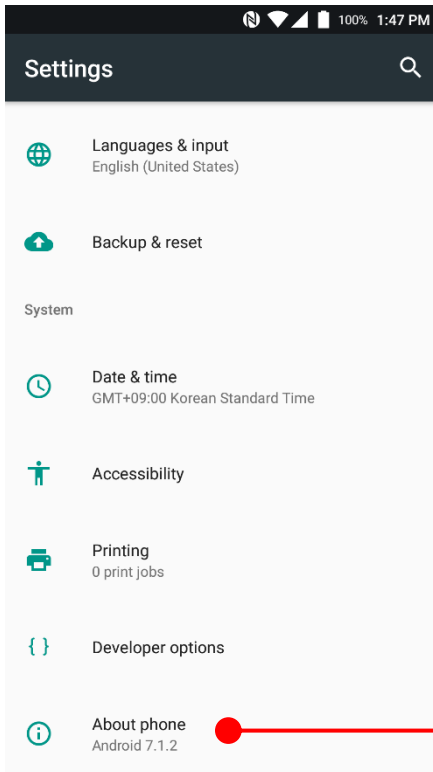

Touch phone”



“App Drawer” →



“Settings” and then “About

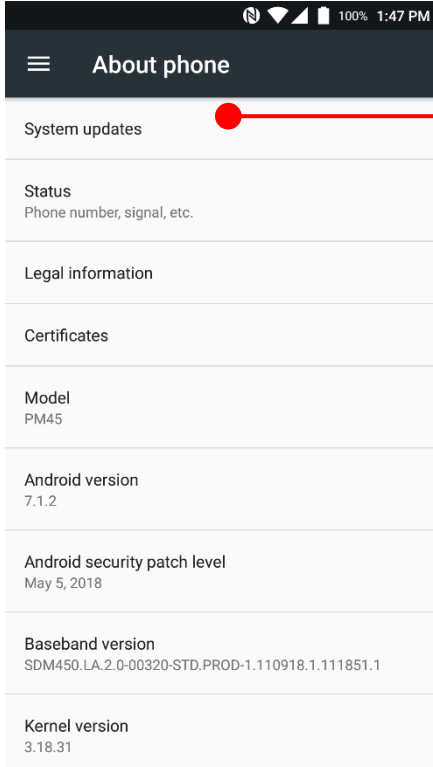

Touch “System Updates”

OS Image update from a Storage

OS Update

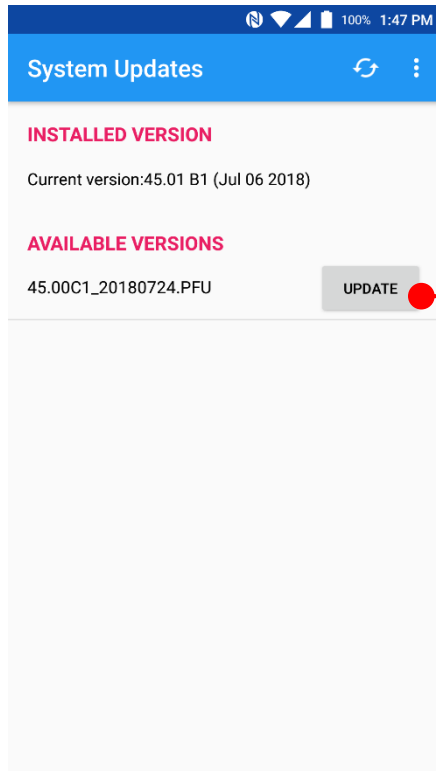

Your PM45 will check storage and display available OS image

Touch "Update" button

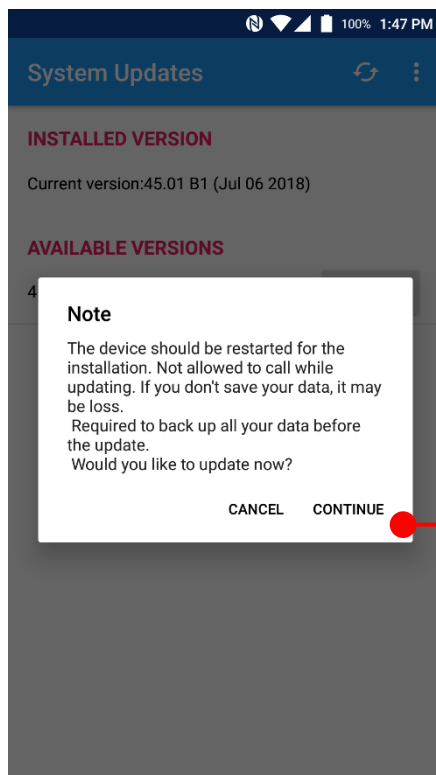



By touching the "CONTINUE" button, your PM45 start to update the OS image. During this time, you cannot use your PM45. Please save the data before start, the OS update process.

Note: Remaining battery level must be higher than 20%. Otherwise PM45 will not start OS update process. Please check battery level first

OS Image update from the FOTA

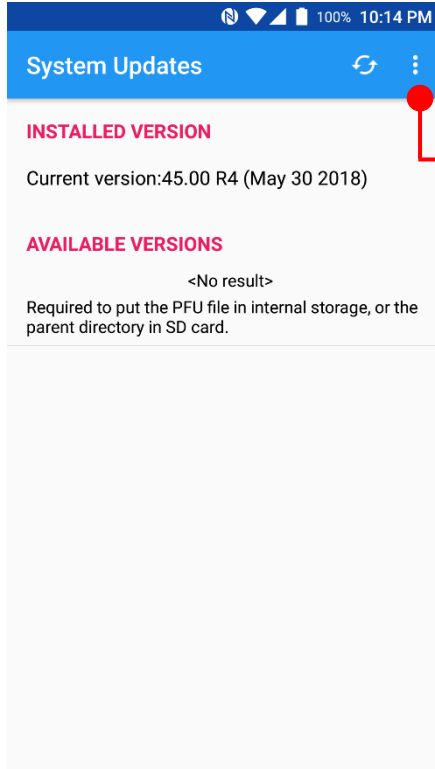
OS Update



Tap  icon for the advanced option

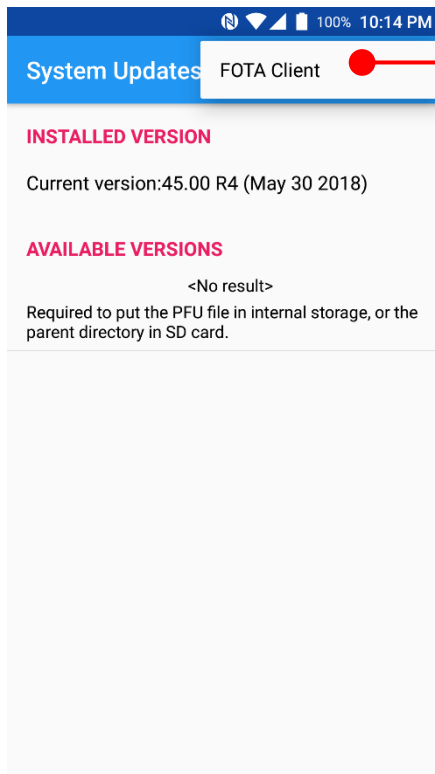

Touch "FOTA Client"

OS Image update from the FOTA

OS Update

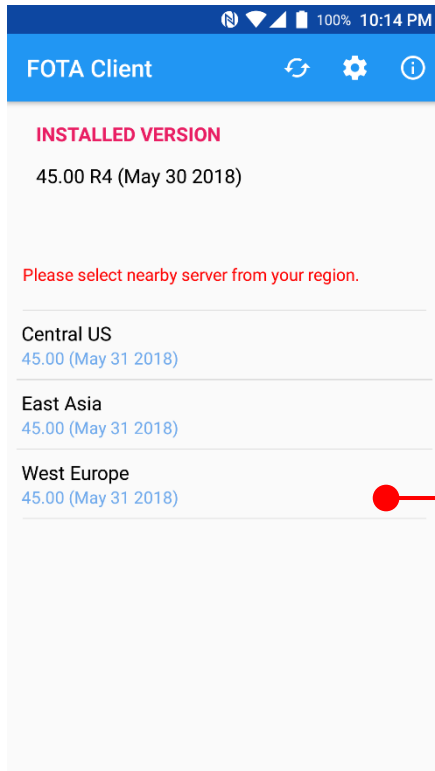

PM45 will compare the OS image between FOTA server and current OS image. If there is newer OS image in the FOTA server, FOTA server will suggest downloading.

Touch the nearby server from your region

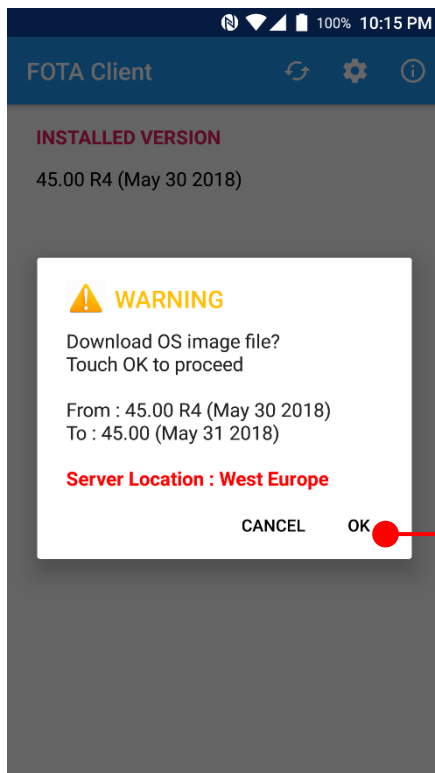

Touch "OK" to start download the image in the FOTA server

OS Image update from the FOTA

OS Update

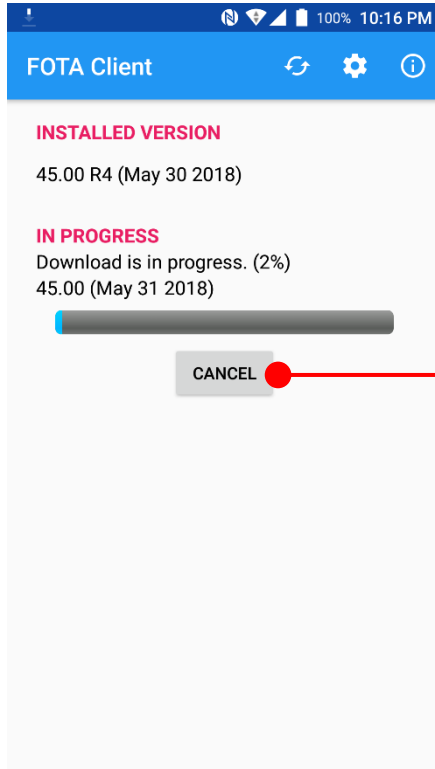

You can cancel OS image download process

Note: Default OS image download setting of FOTA Client is “Download over Wi-Fi only” Please connect to the nearby Wi-Fi network for FOTA service

Remaining battery level must be higher than 20%. Otherwise PM45 will not start OS update process. Please check battery level first

Factory data reset from Settings

Factory data reset

When your PM45 system is unstable and abnormal behavior occur but could not recover by rebooting, you may need to “Factory data reset” your PM45

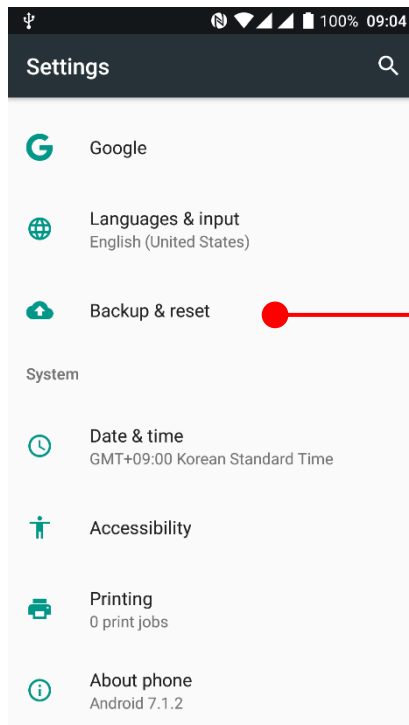

Touch  “App Drawer” →  “Settings” and then “Backup & reset”

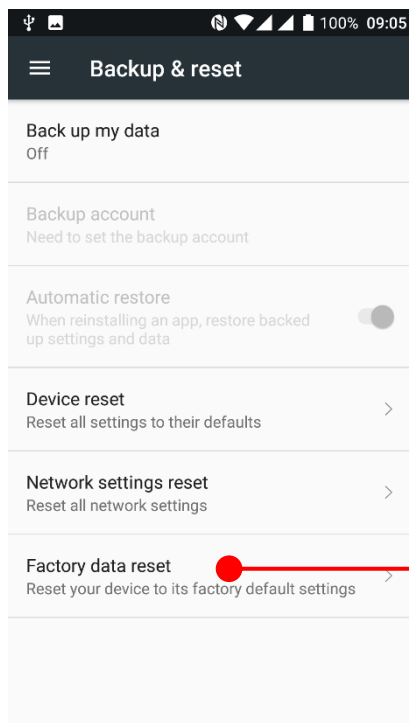

Touch “Factory data reset”

Factory data reset from Settings

Factory data reset

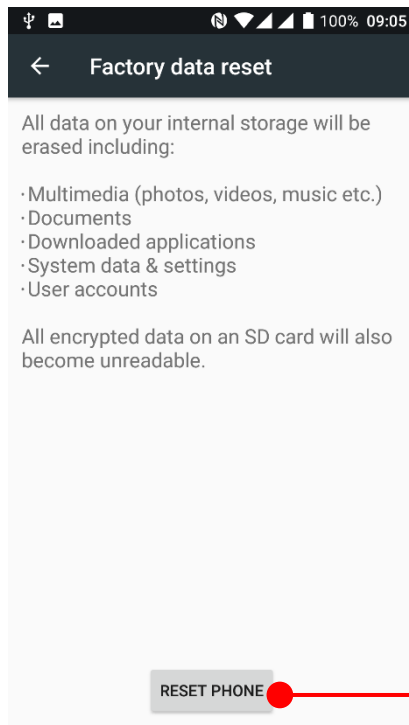

Please note, all apps and data in the internal storage will be deleted and restored to “Factory default” and this process cannot “Undo”

Touch RESET PHONE button to start “Factory Reset” process

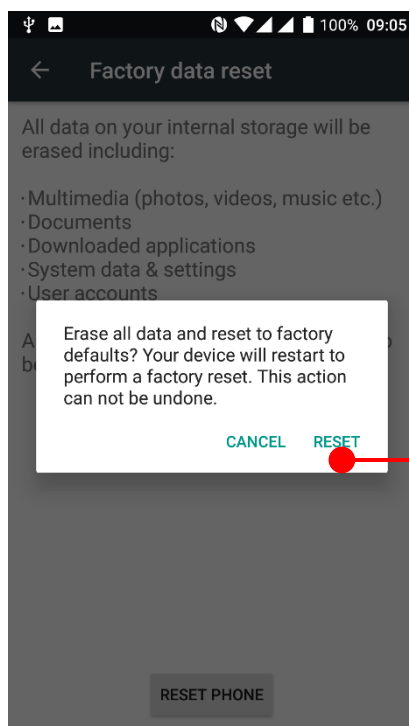

Touch Reset to perform a factory reset

Force Factory data reset

Factory data reset



Force Factory data reset your PM45

You can perform “force” factory data reset your PM45. When your PM45 turned off, press “Power” + “Volume Up” + “Home” button all together. After you see “Smart Beyond Rugged” logo display, you may release the keys.



PM45 enter to the “Android Recovery” mode. In this mode, “Volume up” is “Move Up” in the menu tree and “Volume down” is “Move Down” in the menu tree. “Power Button” is “Select”

Force Factory data reset

Factory data reset



Select "Wipe data/factory reset"



Select "Yes" to perform the "Factory data reset"
After that, your PM45 start wiping the data

Force Factory data reset

Factory data reset

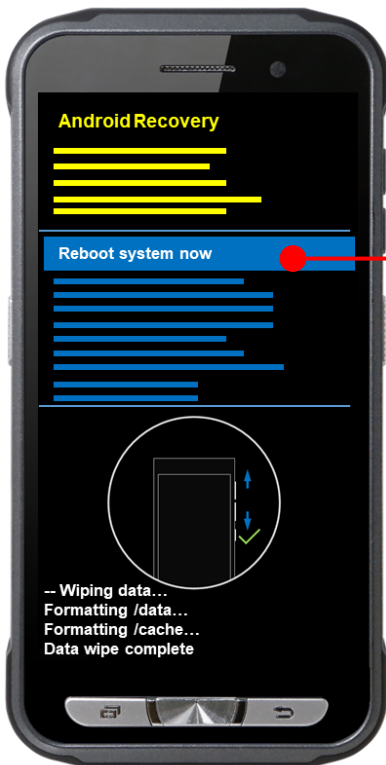

After data wiping, please select "Reboot system now" to finish the "Force Factory data reset" process

Force Factory data reset

Factory data reset

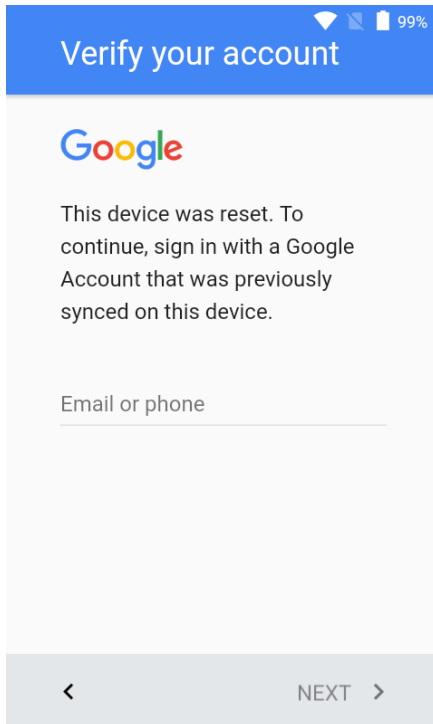

After Force factory reset, if PM Android Device locked by Factory Reset Protection, then please enter to Fast Boot mode and execute command

- fastboot erase config
- fastboot reboot

Note: Factory Reset Protection (FRP) is a security method that was designed to make sure someone can't just wipe and factory reset your device if you've lost it or it was stolen

Enterprise Mobility Kit

EmKit

Enterprise Mobility Kit – Truly, what Enterprise needs

Point Mobile announces new software solution – called “EmKit” is new software solution for enterprise mobility users. Our every Android device shall have EmKit pre-installed and every user can access them for free of charge*. EmKit offers truly-value-added advantages, for enterprise users, which are against consumer-centric & non-customizable smartphones. Every solution in EmKit is 100% compatible with Point Mobile Android GMS certified devices.

* Necessary MDM license subjects upon individual subscribers

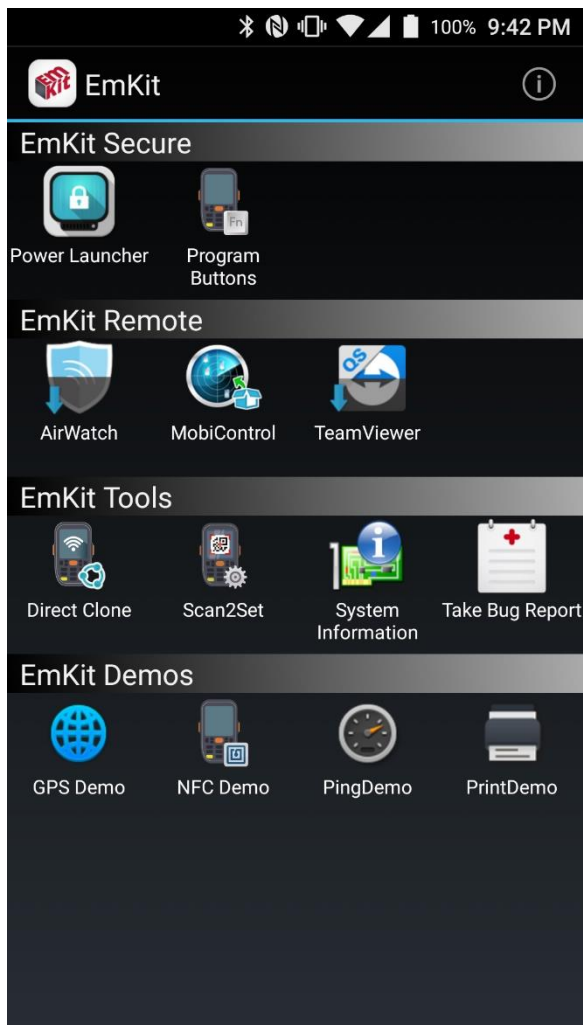

EmKit consist with “**EmKit Secure**”, “**EmKit Remote**”, “**EmKit Tools**” and “**EmKit Demos**”

- EmKit Secure “Lock Your Device”
- EmKit Remote “Mobile Device Management”
- EmKit Tools “Smarty Tools Ease Enterprise”
- EmKit Demos “Friendly For Programmers”

EmKit Secure

EmKit

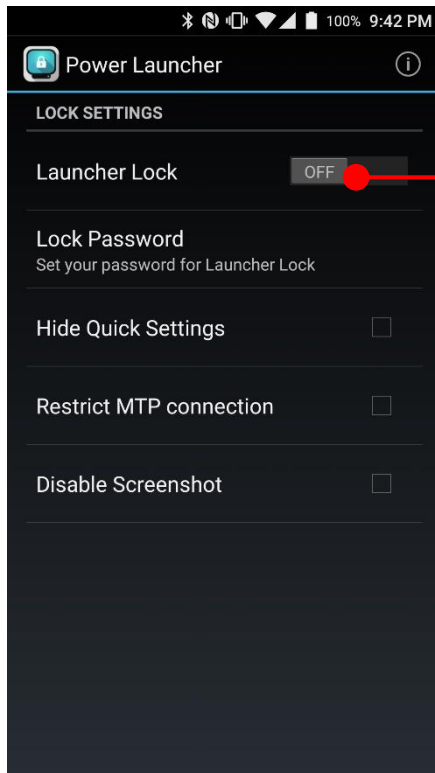

Power Launcher

You can lock your Point Mobile Android model's **Home Screen** and limit to access app drawer or specific function. This function as known as **Kiosk mode**.

- Hide Quick Settings : Limit to access quick setting panel
- Restrict MTP connection : Limit to access Point Mobile Device's MTP connection
- Screenshot Disable : Disable screenshot capture in OS level

Restriction feature will be keep added.

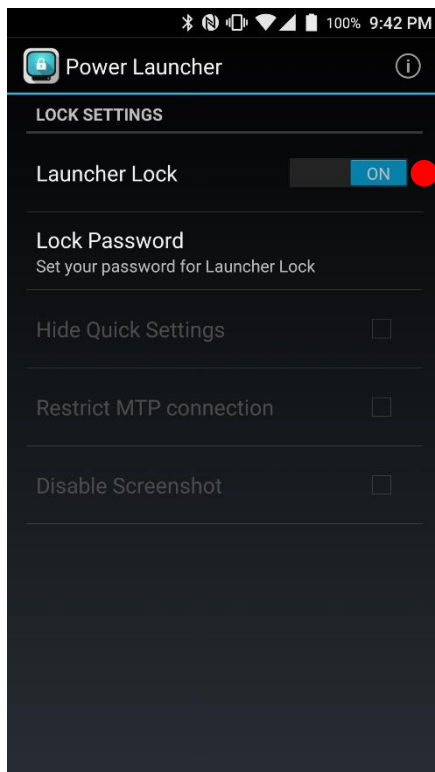

After restriction feature check, switch **Launcher Lock** to On.

EmKit Secure

EmKit

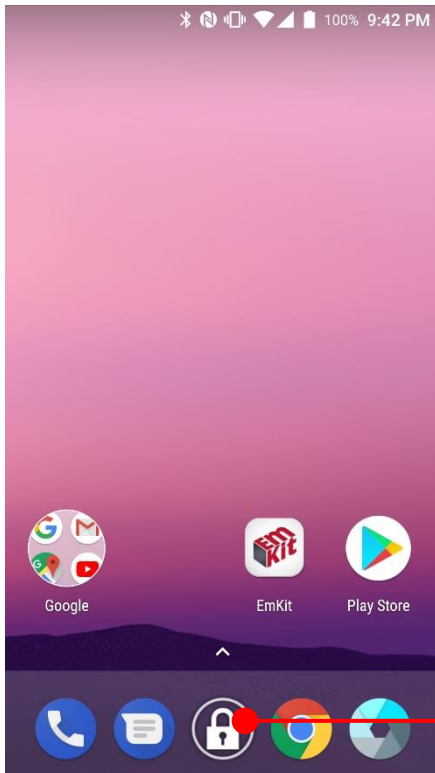

When Power Launcher is locked, operator could not access to **App drawer**.

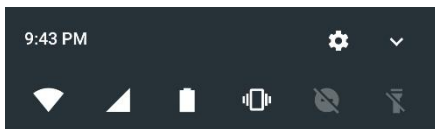

Example of **Screenshot Disable** restriction.

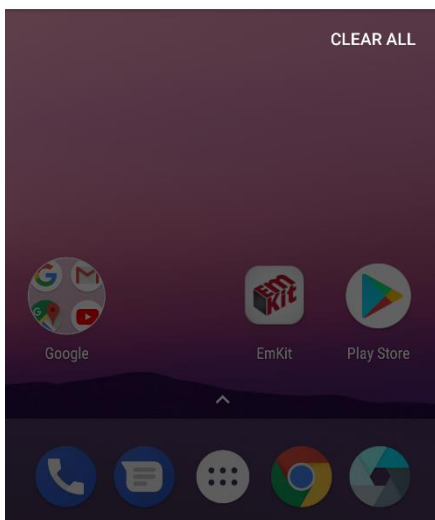

EmKit Secure

EmKit

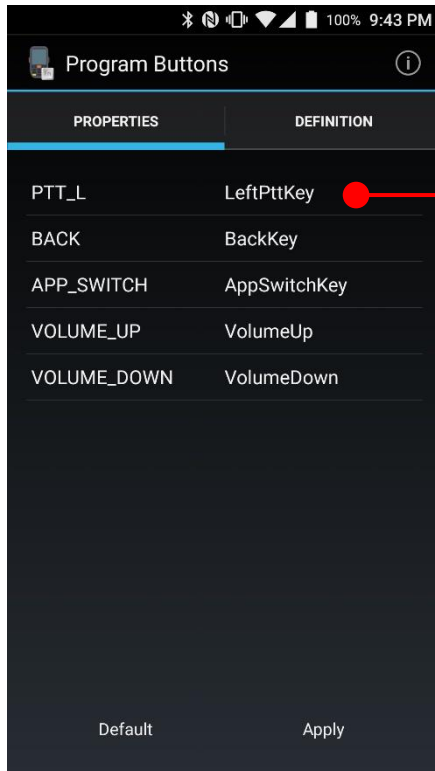

Program Buttons

You can assign Hardware buttons function to rich pre-assigned functions. Also you can applying the customized KCM file (Key Character Map Files) here.

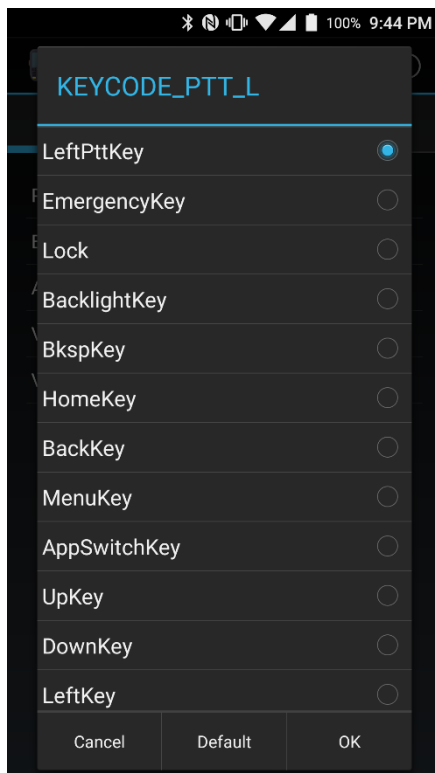

EmKit Remote

EmKit

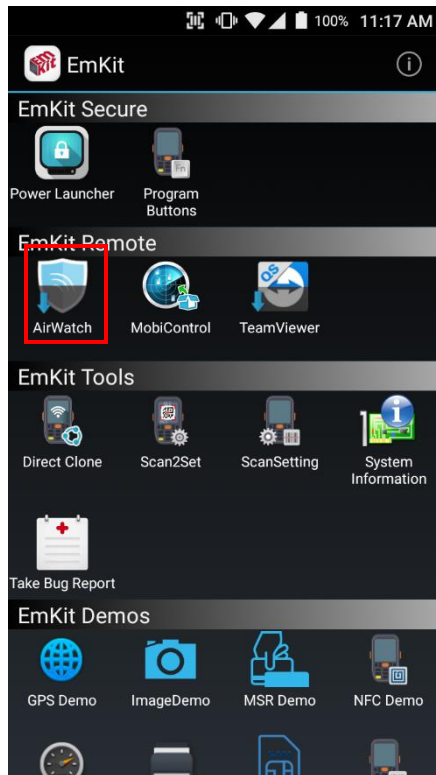

To install the AirWatch agent to Point Mobile Android device, please touch AirWatch icon

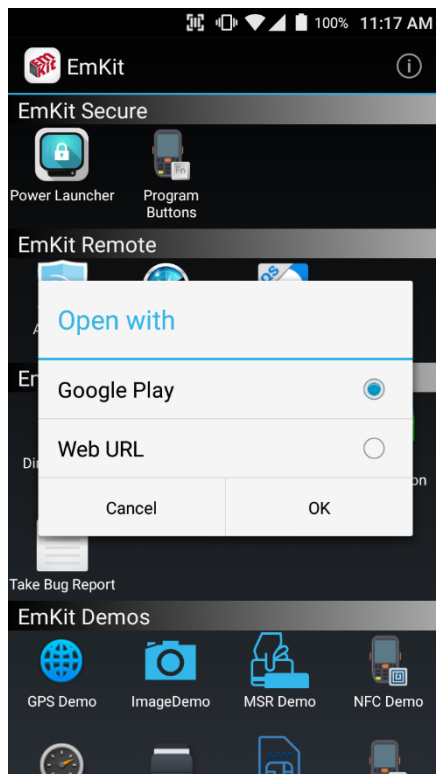

App provides AirWatch agent install via Google Play or Web URL.

- Google Play method requires Google account login. AirWatch agent download and install managed by Google Play
- Web URL method requires user's manual installation

EmKit Remote

EmKit

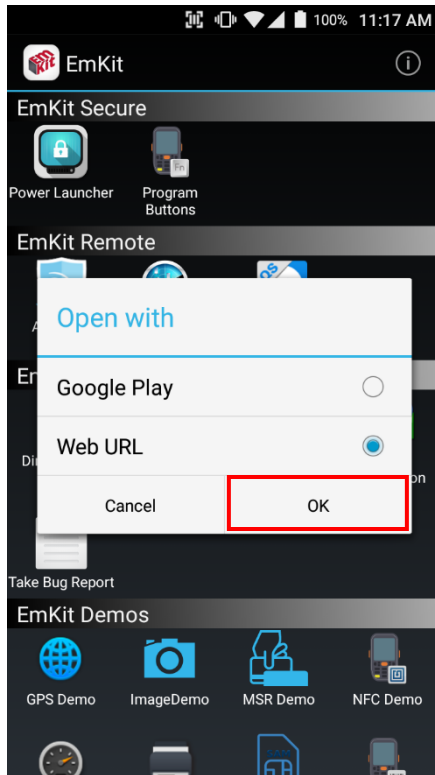

To install AirWatch agent from Web URL method, select Web URL and then **OK**

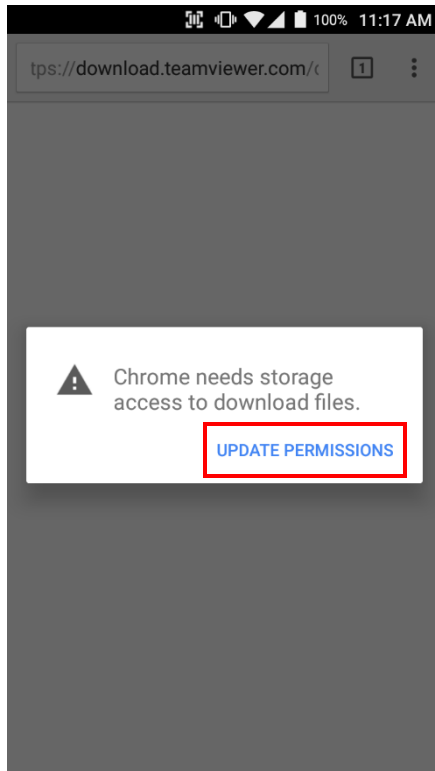

Web browser will download the apk file to the Point Mobile Android device. Before downloading, browser need permission to download apk file to the storage. Please touch **Update Permissions** button

EmKit Remote

EmKit

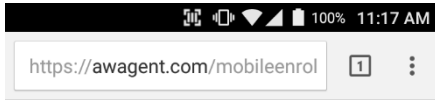

After permission update, web browser download the latest version of AirWatch agent apk file. Install this apk file to Point Mobile Android device.

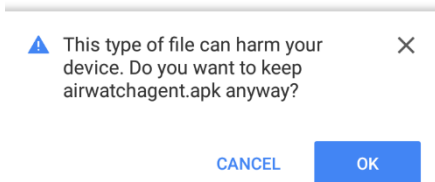

Note: If you need to install specific agent version, please contact to AirWatch

EmKit Remote

EmKit

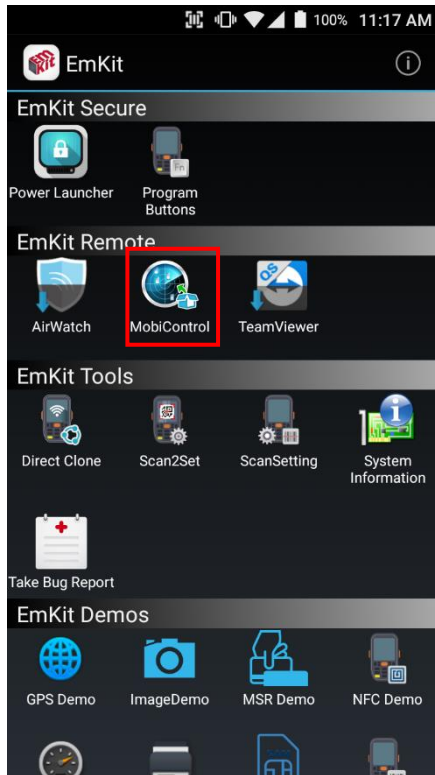

SOTI Mobi Control installer is pre-installed to Point Mobile Android device. To start enrollment process, please touch MobiControl icon

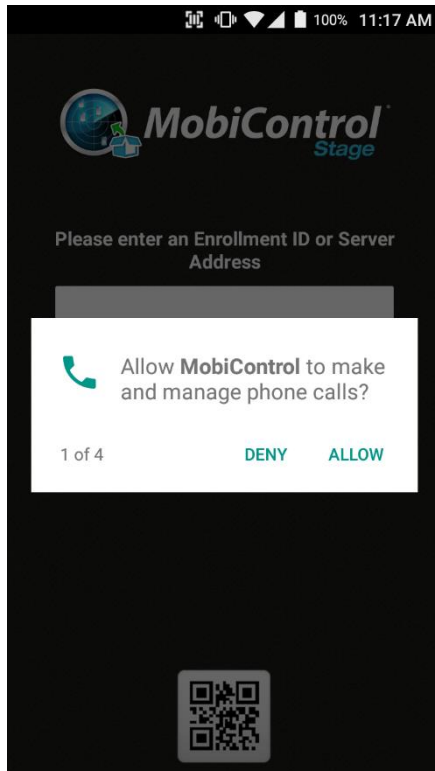

Mobi Control app request permission grant during enrollment process. Please allow it.

EmKit Remote

EmKit

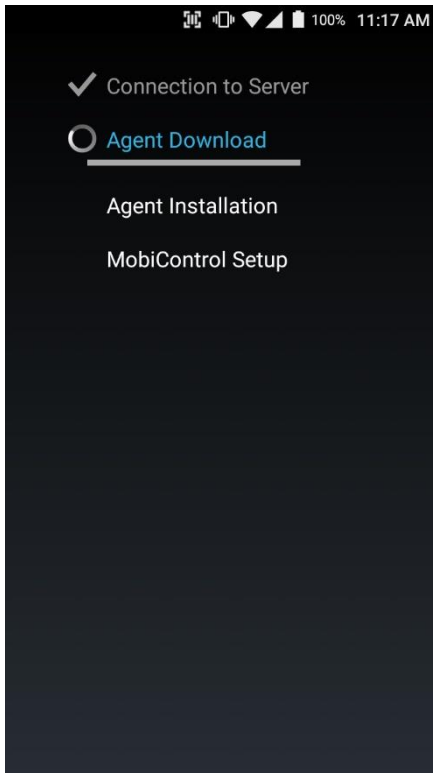

After login, Mobi Control app communicate with SOTI server and then install the Mobi Control agent

Note: Agent version determine from SOTI console's setting. If agent version is incorrect after enrollment, please contact to SOTI

EmKit Remote

EmKit

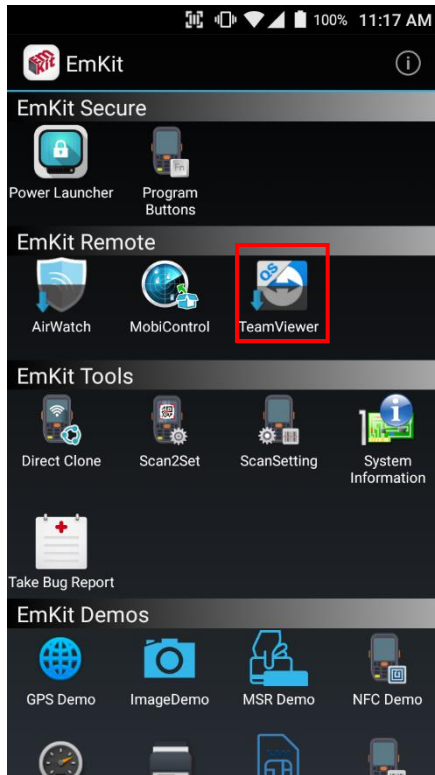

To install the TeamViewer QS app to Point Mobile Android device, please touch TeamViewer icon

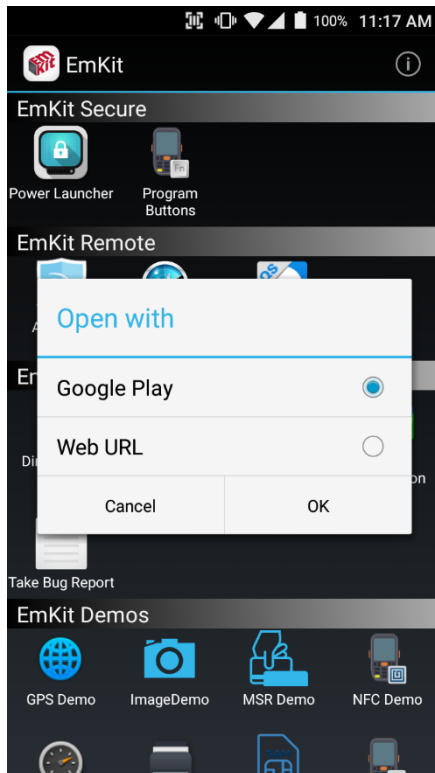

App provides TeamViewer QS app install via Google Play or Web URL.

- Google Play method requires Google account login. TeamViewer QS app download and install managed by Google Play
- Web URL method requires user's manual installation

EmKit Remote

EmKit

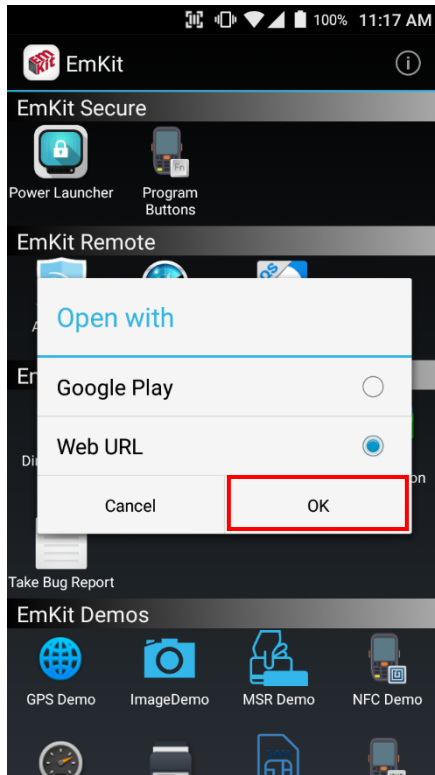

To install TeamViewer QS app from Web URL method, select Web URL and then **OK**

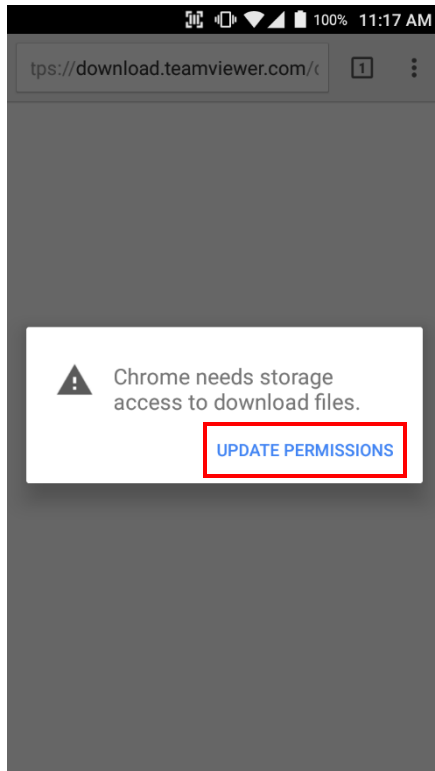

Web browser will download the apk file to the Point Mobile Android device. Before downloading, browser need permission to download apk file to the storage. Please touch **Update Permissions** button

EmKit Remote

EmKit

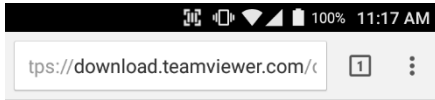

After permission update, web browser download the latest version of TeamViewer QS apk file. Install this apk file to Point Mobile Android device.

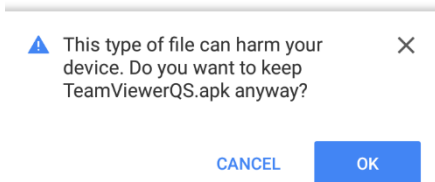

Note: If you need to install specific TeamViewer QS version, please contact to TeamViewer

EmKit Tools

EmKit

Direct Clone

Create the **Master PDA** - backup your system settings and apps into a secured file. Without any network connection, Master PDA become a local server in your work place. Nearby Point Mobile device will automatically communicate with Master PDA and download the backup file and then **Restore**.

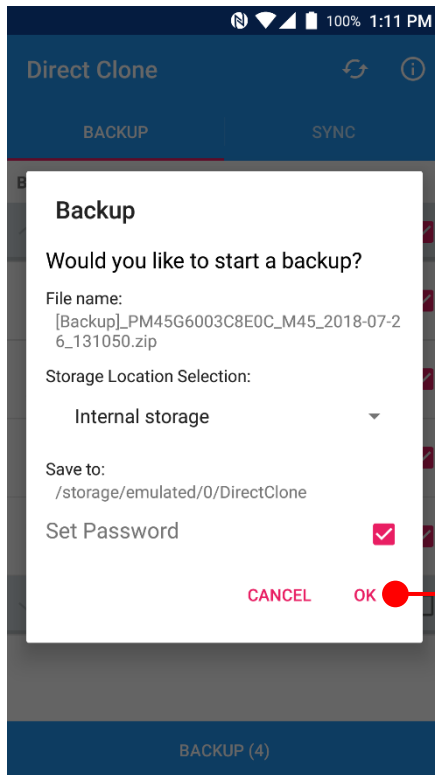

Create the backup file

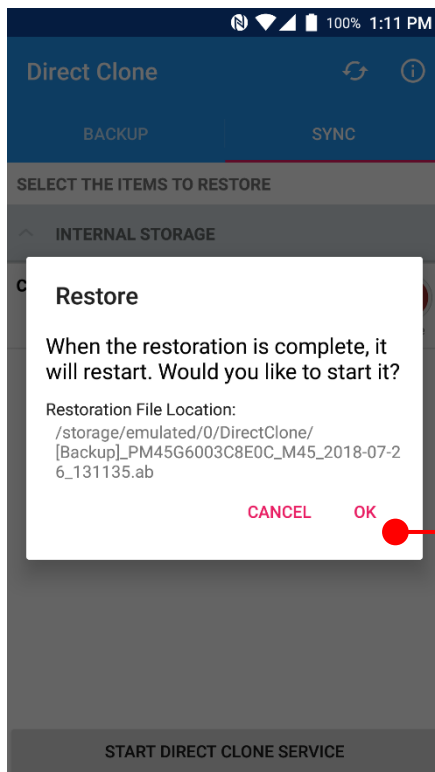

Backed up file will restore your Point Mobile Android device.

EmKit Tools

EmKit

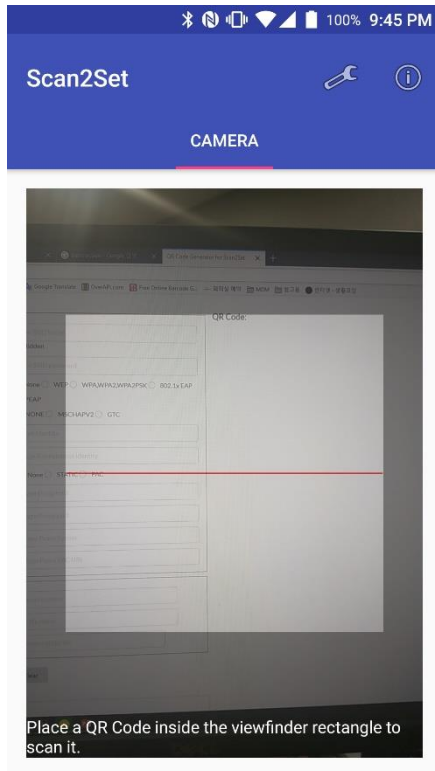

Scan2Set

Scan2Set is designed for the network environment. Point Mobile Android device downloads the Direct Clone file from the FTP, Web server and Google Drive with just one QRcode Scan!

- Scan your QR code and,
- Connect to your network
 - Restore your PDA
 - Work Managed Device setup

Step 1. Create Direct Clone Backup file

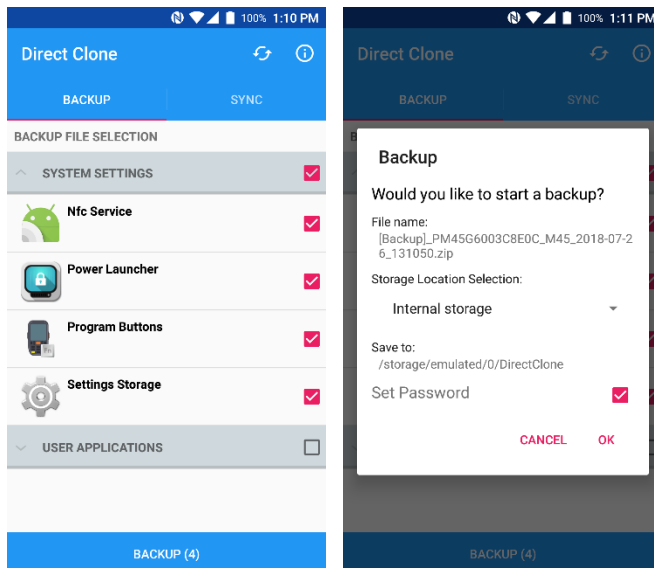

- Make a Direct Clone file from Master PDA device

EmKit Tools

EmKit

Step 2. Upload Direct Clone file to your FTP site or Web server

- Copy the Direct Clone file from the Point Mobile Android device

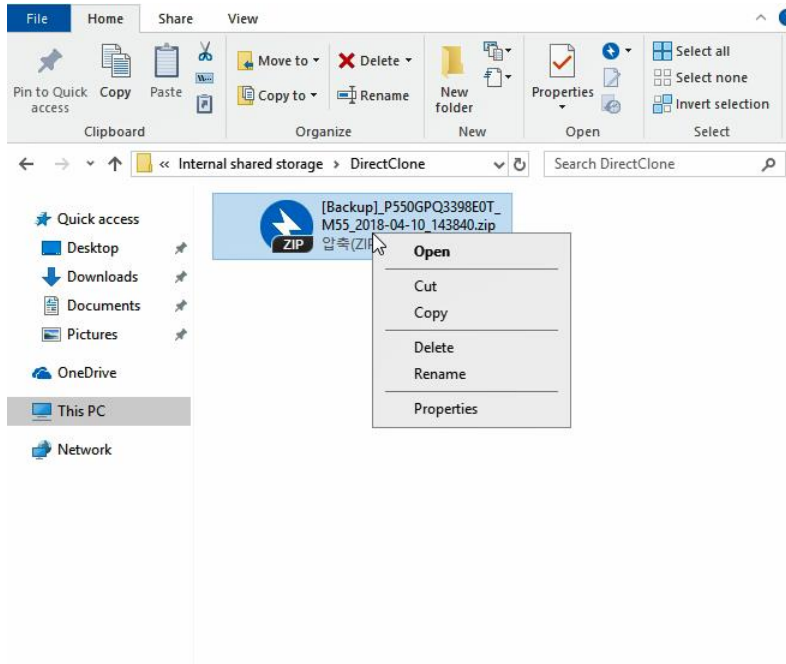

- Upload this file to your FTP site or Web Server. You may change file name

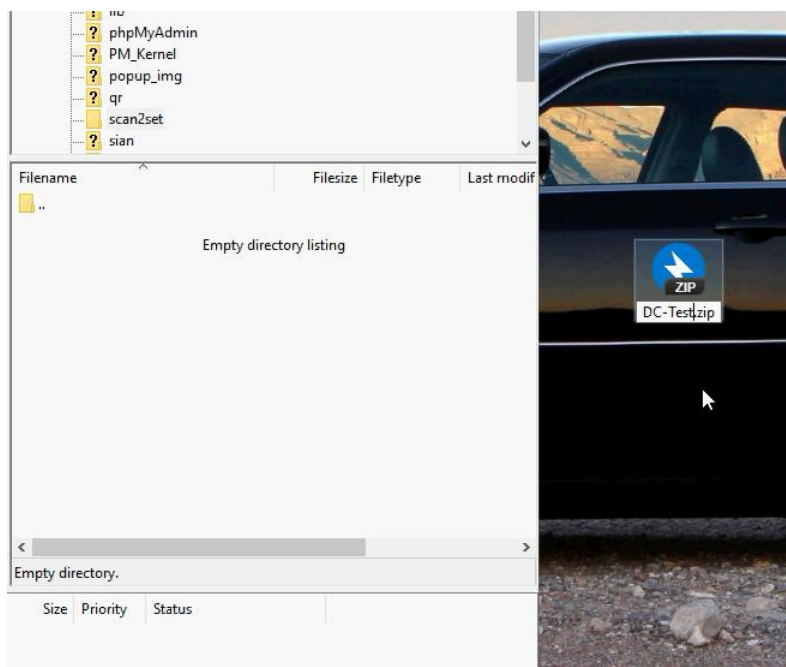

EmKit Tools

EmKit

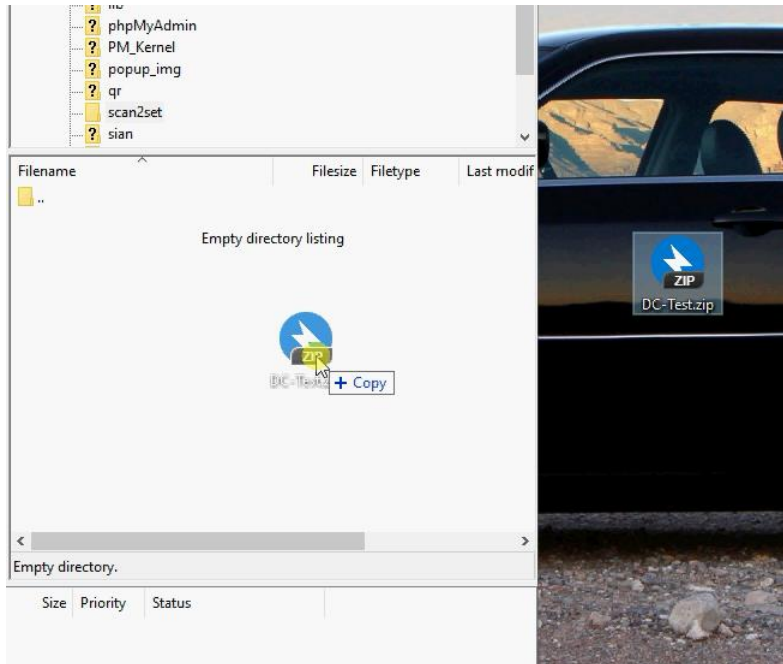

- After file uploading, please check the url first. File should be download with url address.

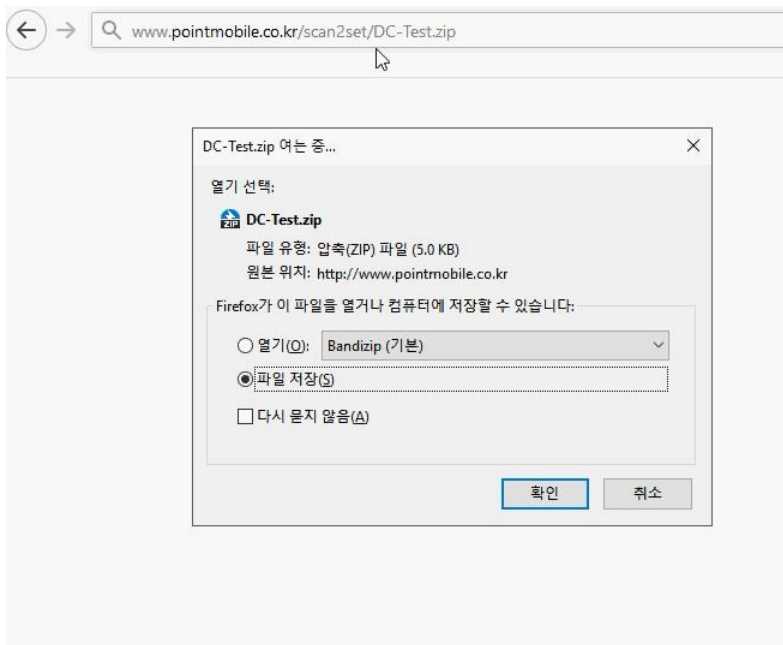

EmKit Tools

EmKit

Step 3. Generate QRcode

- Access to Web QRcode generating site www.pointmobile.co.kr/qr

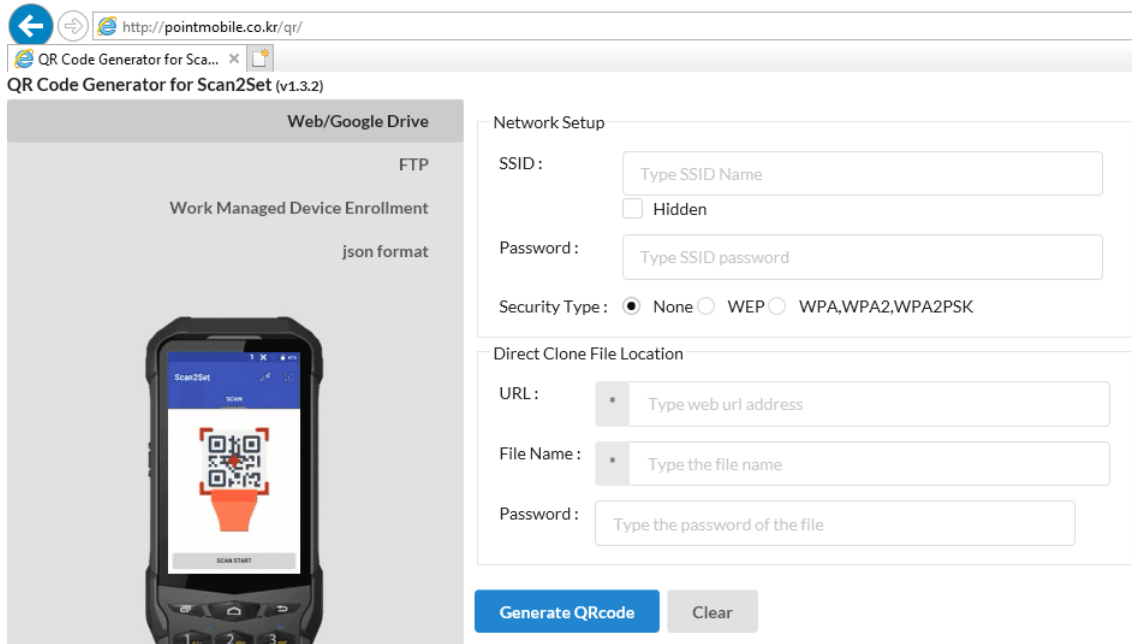

- Click **Web/Google Drive** menu
- Input Network information, Direct Clone file name and password

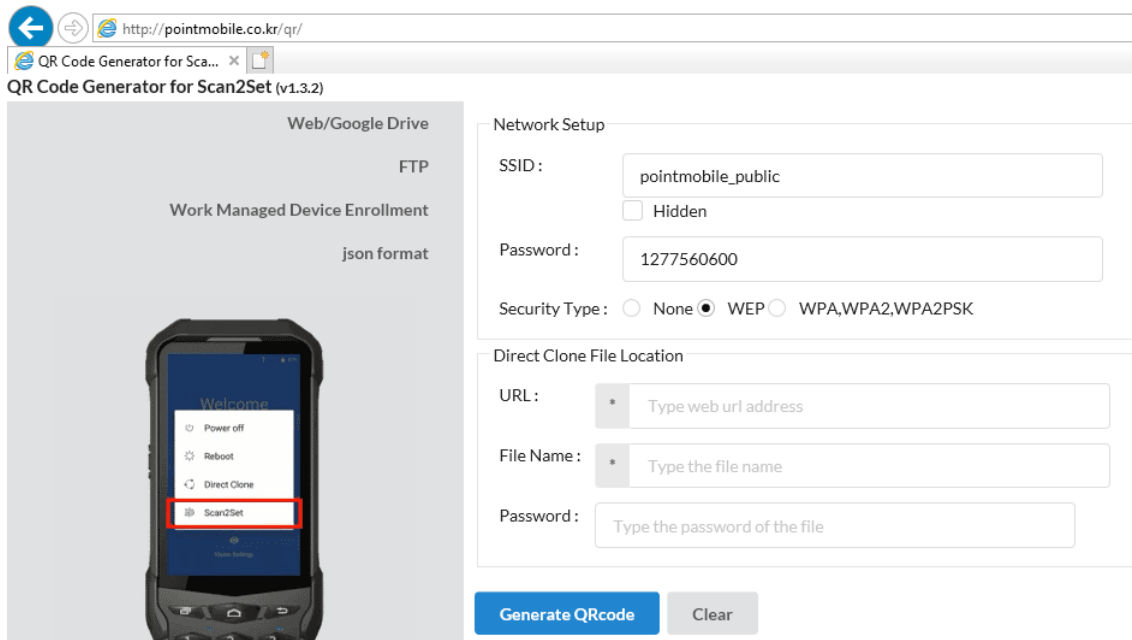

EmKit Tools

EmKit

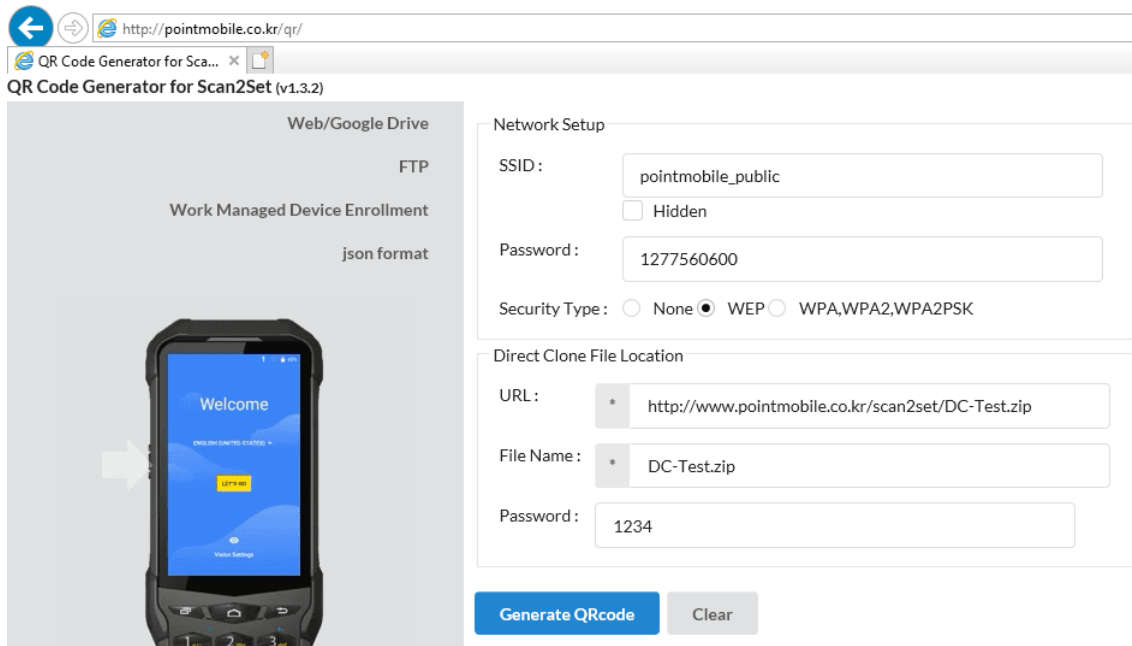

Note: Make sure put http:// or https:// in front of url address

- Click **Generate QRcode** button and save or print generated QRcode

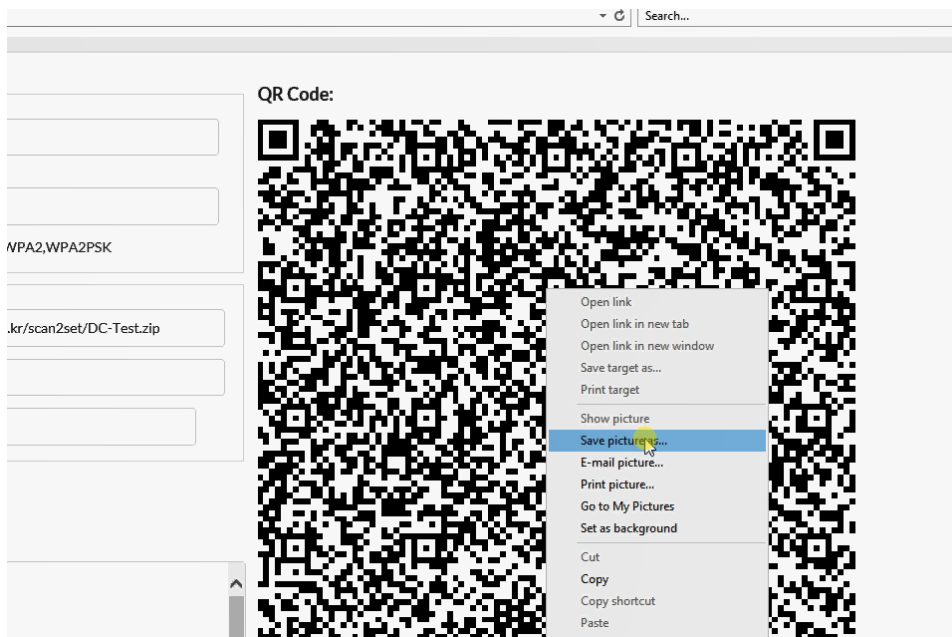

EmKit Tools

EmKit

Step 4. Read QRcode in other PDAs

- Turn on your Point Mobile Android device.
- Press the Power Button, then you will see the Scan2Set in the menu

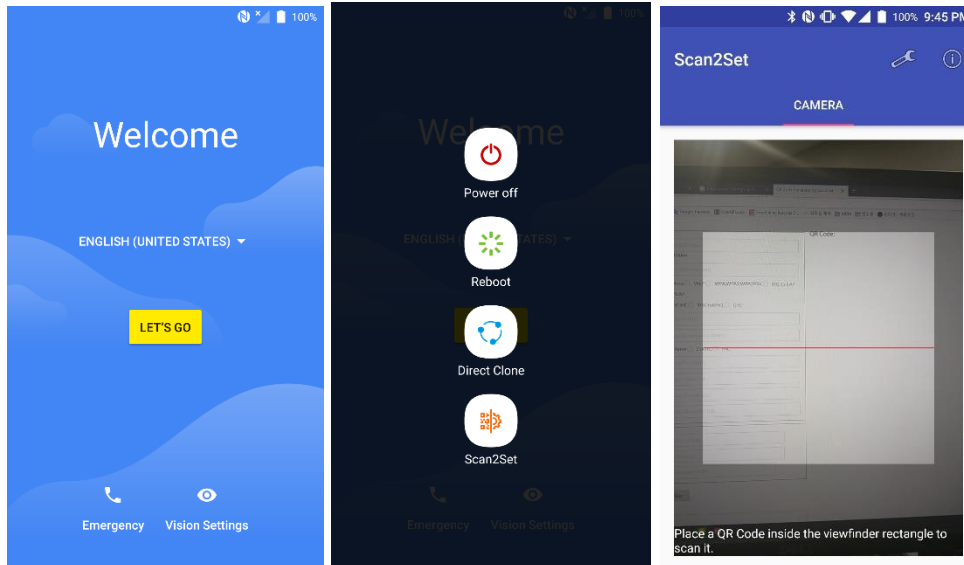

- Read the generated QRcode. Point Mobile Android device will download the file from the FTP site or Web server and restore Direct Clone file

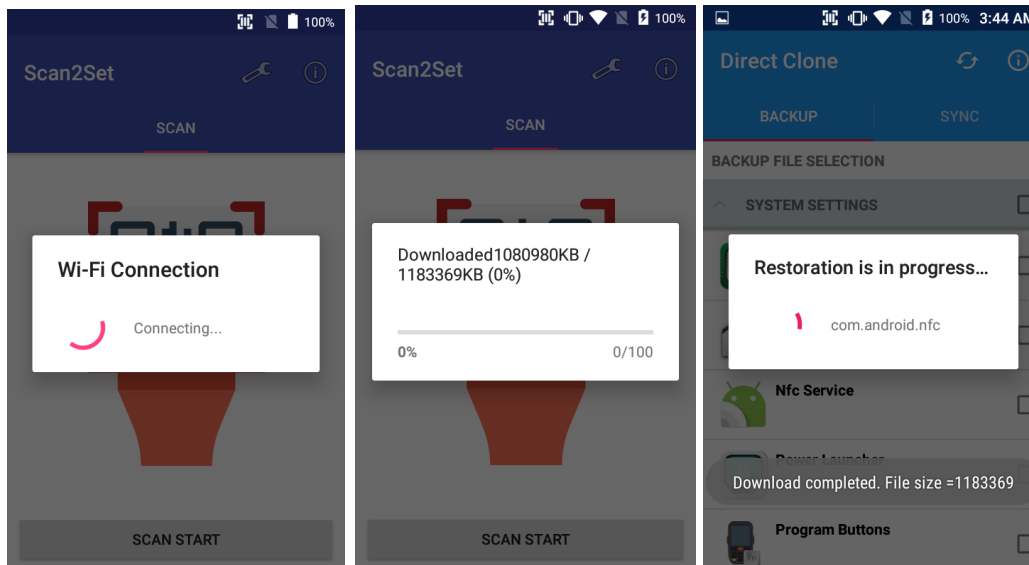

EmKit Tools

EmKit



System information

All of SW and HW information available here and can save it to the file.

- Touch **Save to file**.
- **devinfo.html** file saved to root folder of the internal storage.

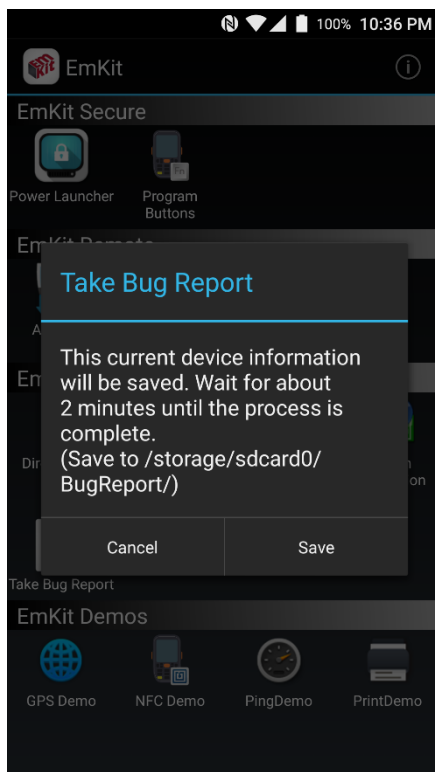

Take Bug Report

This function save logs and event to the internal storage. When you have a field issue, and need to contact service center, please find the reproduce step first.

- Reproduce the issue.
- After issue, reproduce, please run **Take bug report**.
- File will be saved to **BugReport** folder.
- Copy the file to the PC and then zip it to reduce the file size.
- Share bug report file to the service center or Point Mobile Support team with reproduce steps.

EmKit Demos

EmKit

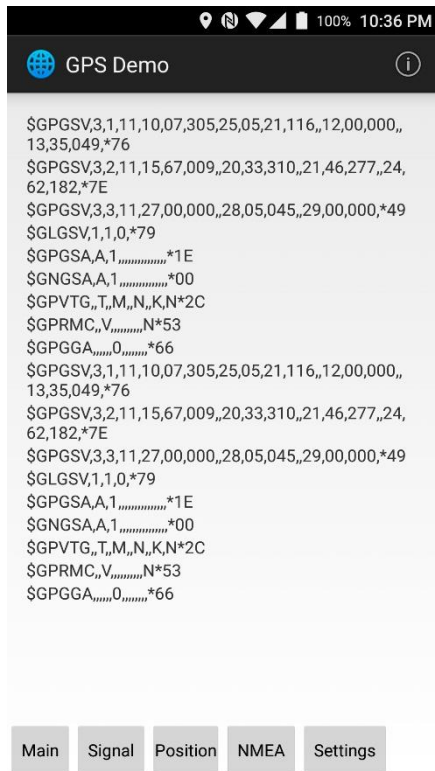

GPS Demo

Developer can demonstrate or check Point Mobile Android model's GPS signal strength, Satellite info, NMEA info.

Some of demo app only available for specific Hardware feature integrated SKU (Stock Keeping Unit)

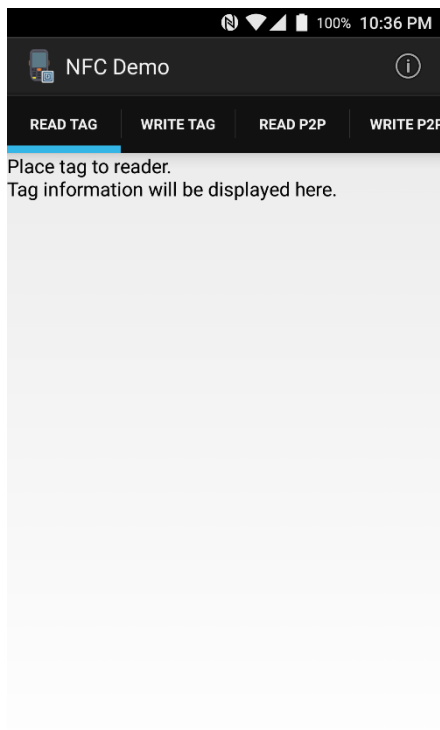

NFC Demo

Developer can demonstrate or check Point Mobile Android model's NFC Read/Write solution.

Some of demo app only available for specific Hardware feature integrated SKU (Stock Keeping Unit)

EmKit Demos

EmKit

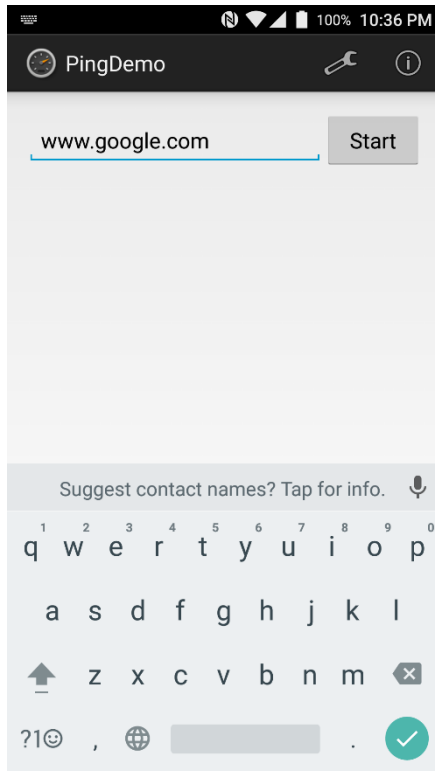

Ping Demo

Developer can demonstrate or check Point Mobile Android model's ping test.

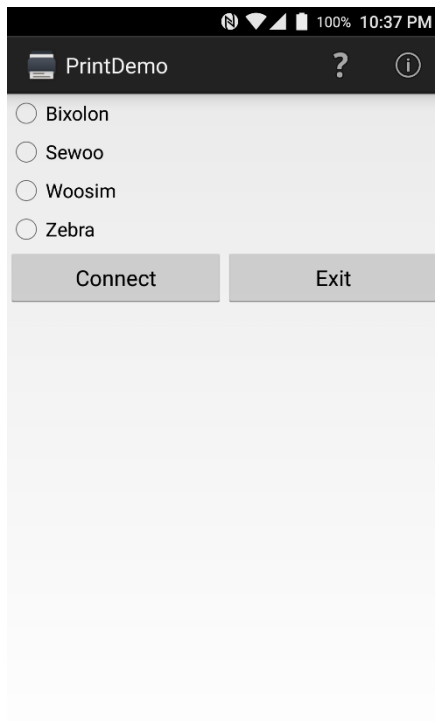

Print Demo

Developer can demonstrate or check Point Mobile Android model's Bluetooth mobile printing solution.

Safety Information

Battery Safety Information

Follow the battery safety guidelines for safe usage, storage, and disposal of Li-ion batteries. Improper battery use may result in a fire, explosion, or other critical hazards.

Battery Safety Guidelines

- Use only Point Mobile approved batteries and charging accessories. Other batteries and chargers may damage the device or result in a fire, leakage, or other hazards.
- Do not expose the battery to excessive heat or cold.
- Do not use or store the battery in or near areas that might get very hot, such as in a parked vehicle, near a heat duct or close to other heat sources.
- Do not allow objects that may cause a short circuit, such as metal objects, corrosive substances, or liquids like water, to contact the battery.
- Do not disassemble, crush, bend, shred, press, or other actions that may damage or deform the battery.
- Do not use or replace the battery on the go or from a high location. Dropping may result in an explosion or fire.
- Do not put any labels, stickers, tags, etc. on the device or battery. Performance of the device or battery, such as sealing, drop, or tumble, could be affected.
- Close supervision is necessary when used near children to avoid the risk of injury.
- If battery leakage is observed, avoid any contact with the skin or eyes and properly dispose of the battery. If contact has been made, wash the affected area with water for 15 minutes and seek medical advice.
- If you notice any type of damage to the battery, such as swelling, dents, and leaks, stop using it immediately and contact Point Mobile.

Battery Charging Guidelines

- Charge the battery in a clean, cool, dry, and ventilated environment.
- Separate the charger from the battery as soon as possible when the battery is fully charged.
- Battery performance can degrade due to the stress of daily charging and discharging. Batteries typically need to be replaced after 300 to 500 charging cycles (full charge-discharge cycles) or when the battery capacity has been reduced to 70 ~ 80% of its original capacity. The actual number of charging cycles varies based on usage patterns, temperature, age, and other factors.

Safety Information

Battery Storage / Disposal Guidelines

- Store the batteries in a clean, dry and ventilated environment within ambient temperature ranges of $20\pm 5^{\circ}\text{C}$.
- For safety regulations, batteries are charged to below 20~30% of full capacity during production.
- When not using batteries for a long period, charge the battery for 30 minutes to 1 hour at least once every 6 months to prevent full discharge and keep the performance.
- Batteries should be stored separately when storing for long periods. Disconnect from any device, charger, or cradle.
- Dispose of used batteries promptly according to local disposal regulations.
- Do not dispose of the battery in fire. It may cause explosion.



Notice: The battery is consumable. Point Mobile provides a warranty for the battery for 12 months after purchase.

If you suspect the battery swelling, change the battery immediately and contact Point Mobile.



Point Mobile. Co., Ltd.

Offline

Tel: +82-2-3397-7870~1

ARS: +82-1800-3010

Fax: +82-2-3397-7872

Address: 9F Kabul Great Valley, 32, Digital-ro 9-gil,
Geumcheon-gu, Seoul, Korea 08512

Online

Website: <https://www.pointmobile.com>

E-mail: pm_support@pointmobile.com