

Quick Start Guide

PM452

Device Parts

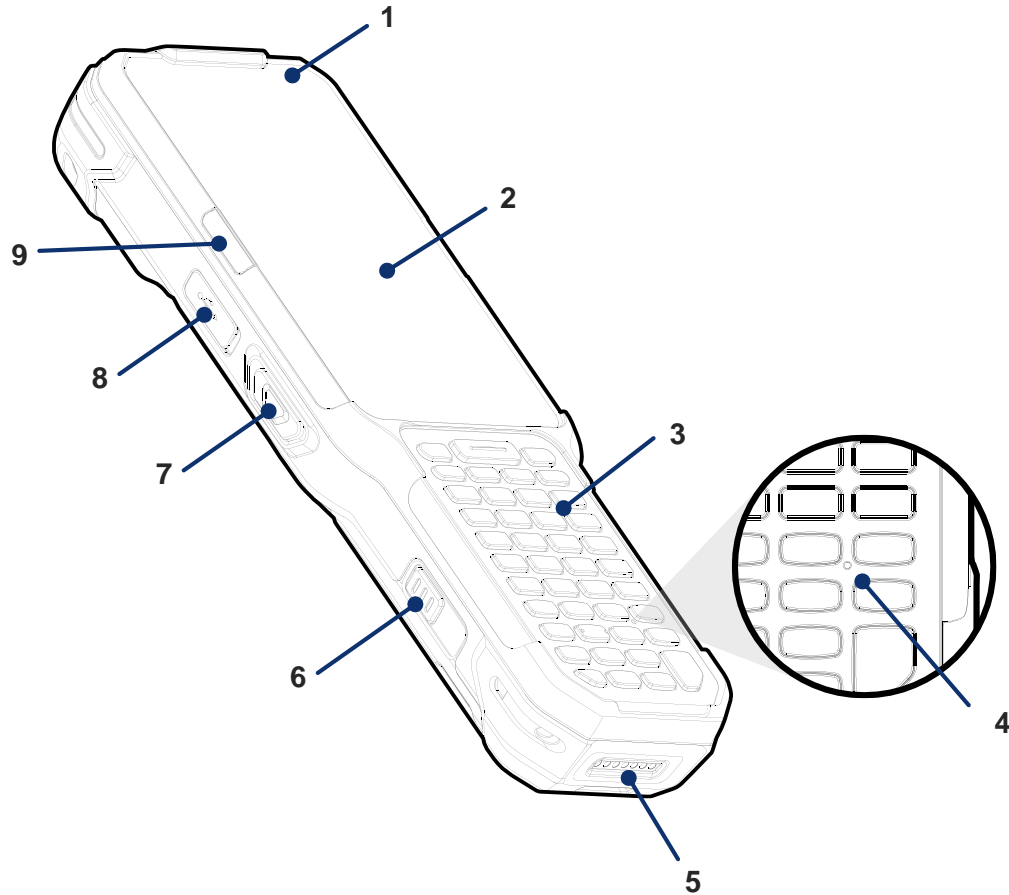

1. LED indicator (Front)
2. Touch screen
3. Keypad
4. Microphone
5. I/O connector for cradle
6. Battery release button (Left)
7. Scan button (Left)
8. USB connector with cap
9. LED indicator (Center-Left)

Device Parts

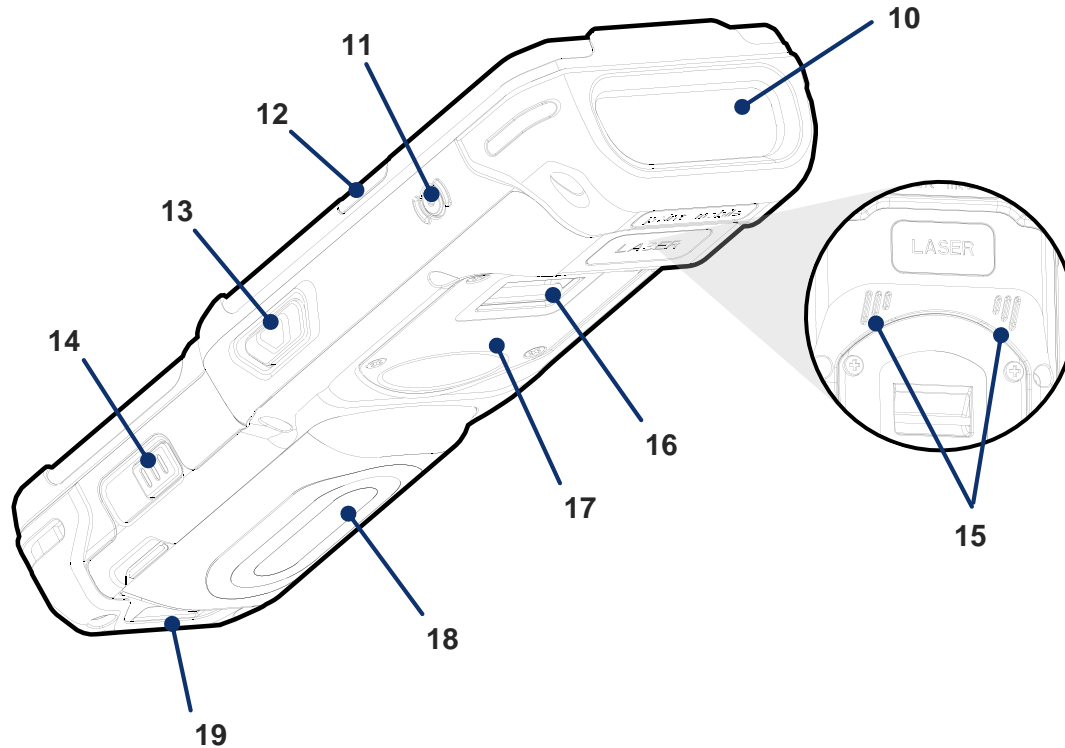

- 10. Scanner & Top camera
- 11. Power button
- 12. LED indicator (Center-Right)
- 13. Scan button (Right)
- 14. Battery release button (Right)
- 15. Speaker
- 16. Hand strap hole (Top)
- 17. Gun handle connect part
- 18. Battery
- 19. Hand strap hole (Bottom)

Product Standard Accessories



Battery pack



Charger



AC Plug



Stylus pen



Hand strap



LCD protection film

Battery Replacement

Install Battery

1. Insert the battery from the top side (opposite side of the gold contacts).
2. Push the battery down firmly
Check if the battery release buttons are completely outward.

Remove Battery

While pressing the battery release button in, pull the battery's bottom side up.

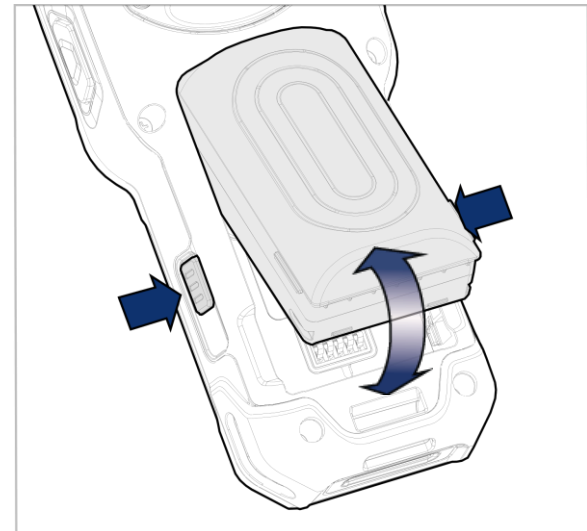

Installing SIM, SD card

PM452 supports

- 1 micro SD card slot
- 1 micro SIM card slot - WWAN (LTE) SKU only

1. Remove the battery and open the card slot cover.

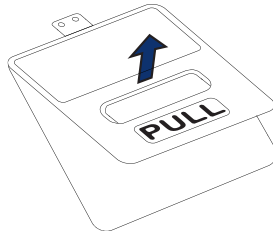

2. Insert a SD or SIM card with the contacts facing down.

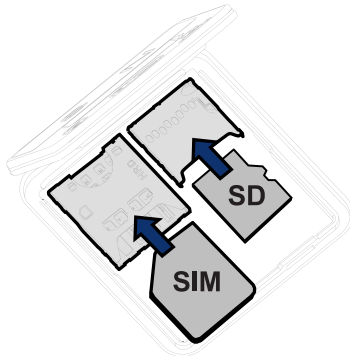

3. Close the card slot cover firmly.

Turning on / off

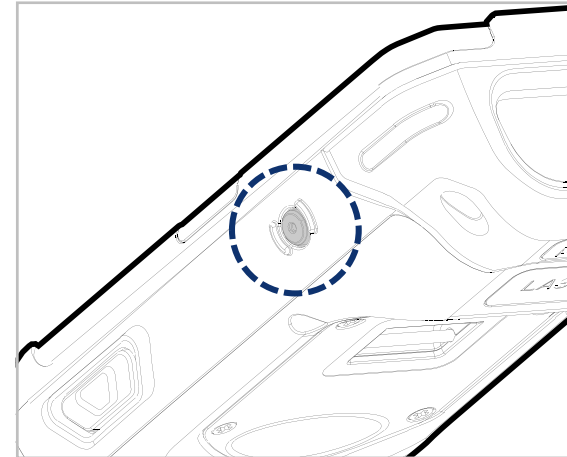

Turn on

Press and hold the **Power** button on the right side until the **SMART BEYOND RUGGED** logo displays on the screen.

Turn off

When the screen is on, press and hold the **Power** button until the power menu is shown.

Then, tap **Power off** among the menu.

Charging the Device

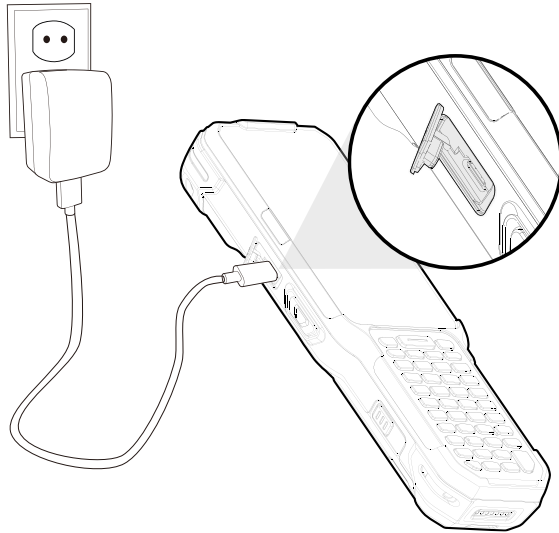

1. Assemble a proper country plug and the charger, and rotate the plug clockwise to engage firmly.
2. Open the USB connector's cover cap on the PM452.
3. Connect the cable to the USB connector.
4. Provide power by plugging the power adapter to the wall socket.

PM452 can also be charged with a charging cradle. The cradles are sold separately and can be used in common with PM451.

< Caution >

1. Always use an original charger from Point Mobile. Other chargers may damage the PM452. The device warranty does not cover any damage caused by the usage of non-original power supplies.
2. Make sure the charger and cable is not wet.
3. Charge in temperatures from **0°C to 45°C**.

LED Indicator

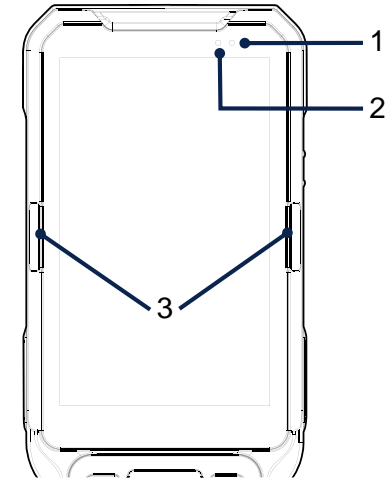

No	Indicator	Status	Indication
1	Notification LED	Solid red	Device entered hot swap mode
		Blinking blue	Notification existing
2	Power LED	Solid green	Device is fully charged
		Solid red	Charging the device / Battery is low
		Blinking red	Charging temperature is out of normal range / Battery is very low
		Alternately blinking red & green	Cannot recognize the battery
3	Center LED	Red flash	Barcode reading failed
		Blue flash	Barcode reading success

Using Keyboard Backlight

Turn on the keyboard backlight when the keypad is not visible in a dark place.



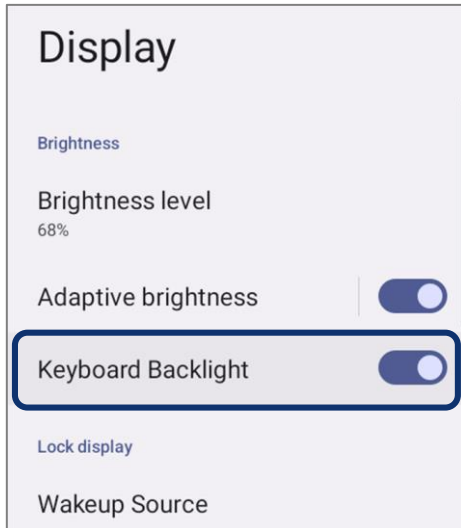



1. Go to **Settings**  > **Display**.
2. Turn the **Keyboard Backlight** switch on.



Using Keypad Functions

Control volume, display brightness, keyboard backlight brightness using key(s) on the keypad.

Some function is available using a key combination with Function (**Blue**) button.

Function	Key Combination		
	Numeric	Alpha-Numeric	Function-Numeric
 Volume down	Fn + 2	Fn + P	Fn + F8
 Volume up	Fn + 3	Fn + J	Fn + F4
 Display brightness down	Fn + 4	Fn + K	Fn + F5
 Display brightness up	Fn + 7	Fn + E	Fn + F1
 Keyboard backlight brightness down	Fn + 6	Fn + W	Keyboard brightness down
 Keyboard backlight brightness up	Fn + 9	Fn + X	Keyboard brightness up

Scan a Barcode

Scanner is enabled by default. If the scanner is not enabled, turn on the scanner from **ScanSettings** first.

Check if the scanner icon  is placed on the Status bar. Then, press a scan button to scan a barcode.

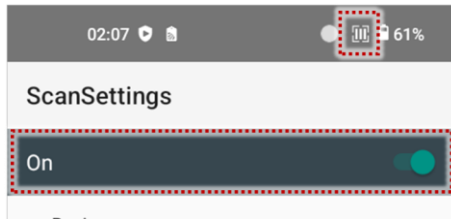

Center the aimer (laser cross-hair or red dot) over the barcode.



N5703 Scanner SKU

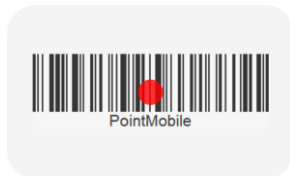

**N6803FR / EX30
Scanner SKU**

Certification

- Model: PM452
- Trade name of certified: Point Mobile Co., Ltd.
- Manufacturer : Point Mobile Co., Ltd.
- For more certificate information, go to **Settings > About phone > Certificates**.

Support

- ARS : +82-1800-3010
- FAX : +82-3397-7872
- Address : 26F, Gasan Publik Building A, 178, Digital-ro, Geumcheon-gu Seoul, Korea 08513
- Website : <https://www.pointmobile.com>
- E-Mail : pm_ta@pointmobile.com